

(PL) Instrukcja montażu

(GB) Assembly instructions

(DE) Montageanleitung

(FR) Notice de montage

(IT) Istruzioni di montaggio

(NL) Montage-instructies



>5F 8-B '75FF 9, I)

UWAGA /REMARQUE/ /NOTE/ ATENZIONE /HINWEIS /LETOP

(PL) Maksymalna wysokość słupa wody ~ 1.2 m

(FR) Niveau maximum de la colonne d'eau ~ 1.2 m

(GB) The maximum water column level ~ 1.2 m

(IT) Livello massimo della colonna d'acqua ~ 1.2 m

(DE) Maximaler Wasserstand ~ 1.2 m

(NL) Maximum niveau waterkolom ~ 1.2 m

(PL) Objętość wody w basenie 40.99 m³

(FR) Le volume de l'eau dans la piscine 40.99 m³

(GB) Water capacity in the pool 40.99 m³

(IT) Il volume di acqua in piscina 40.99m³

(DE) Volumen von Wasser im Schwimmbecken 40.99 m³

(NL) Water inhoud van het zwembad 40.99 m³

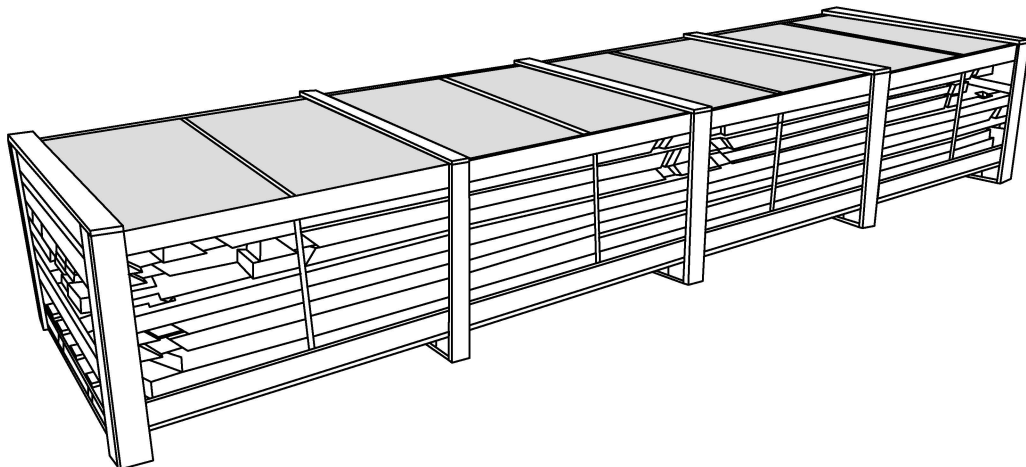
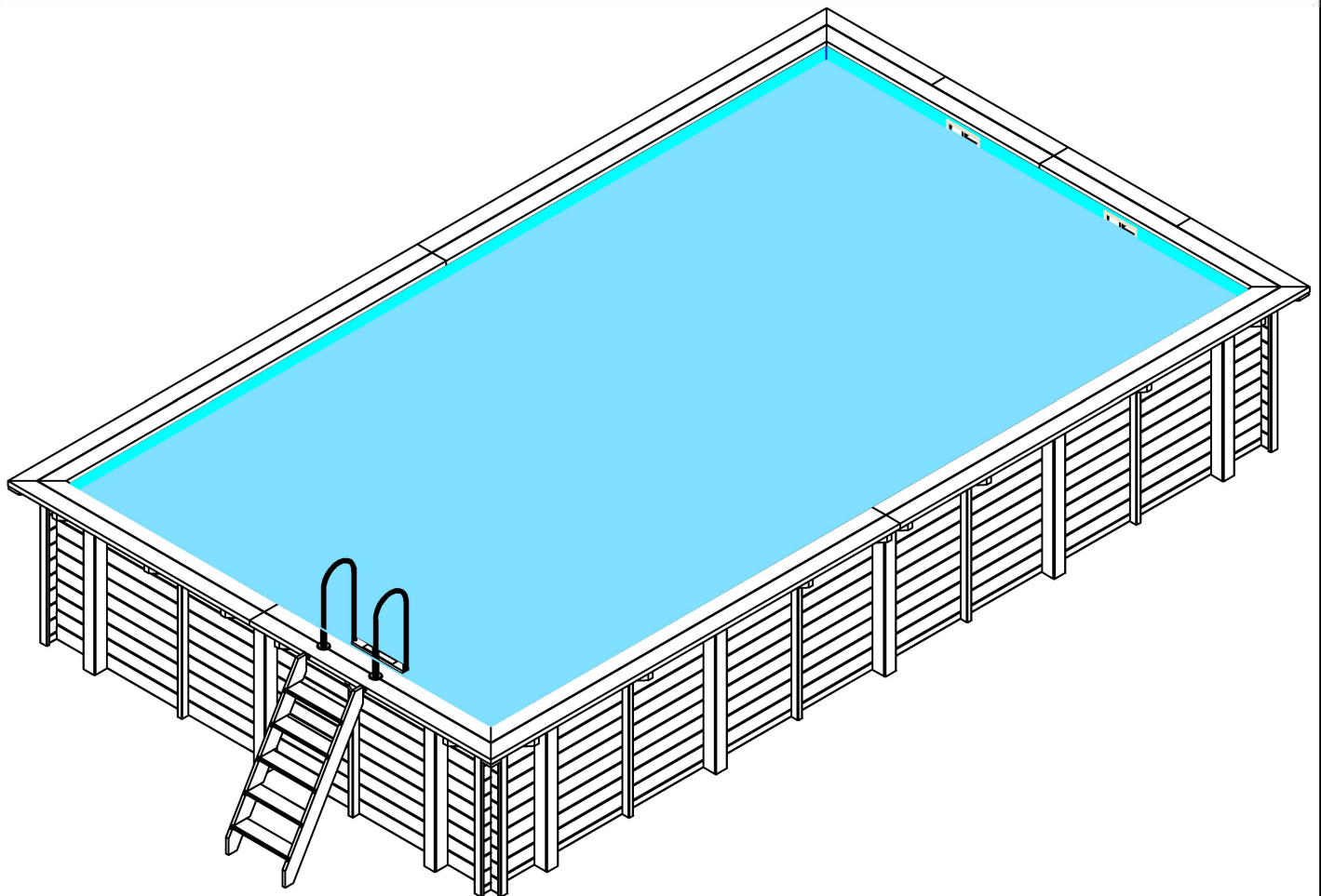

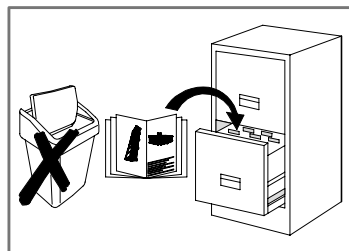
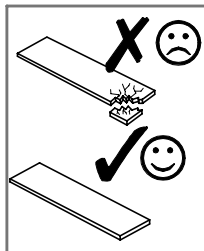
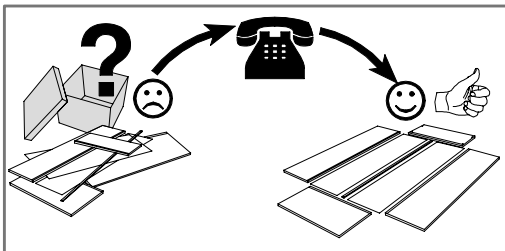
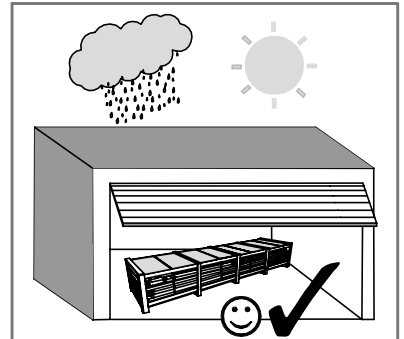
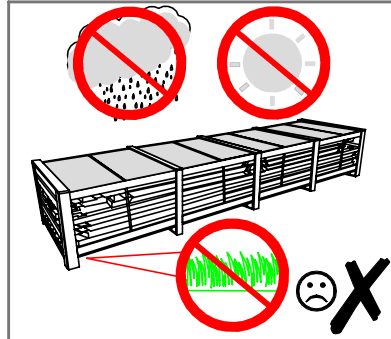
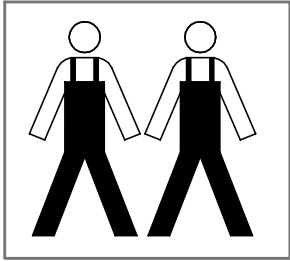
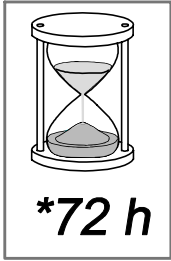

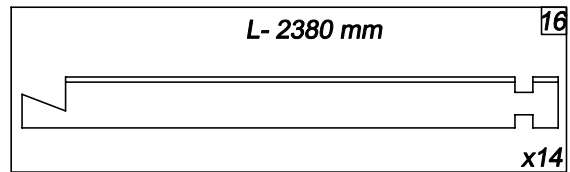
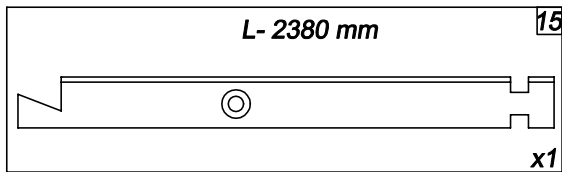
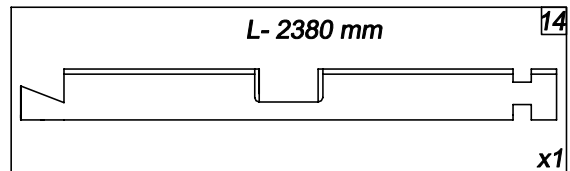
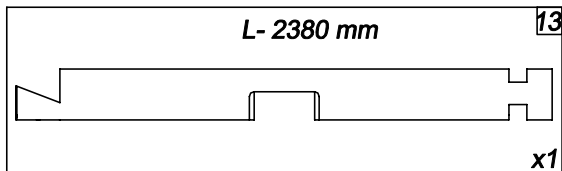
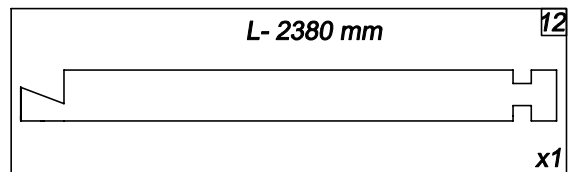
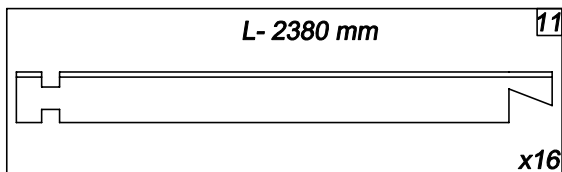
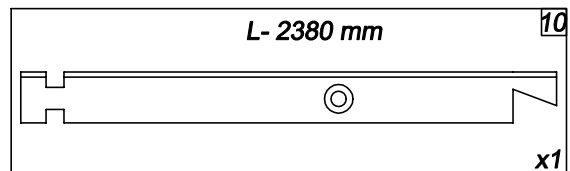
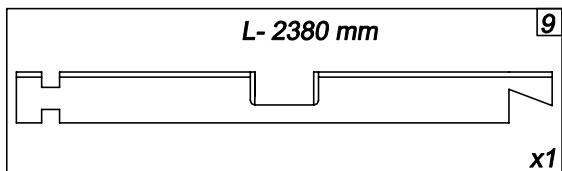
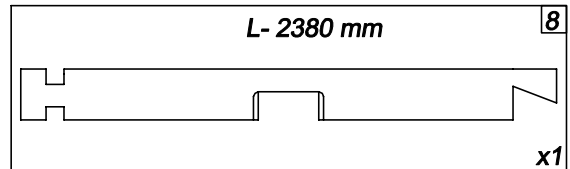
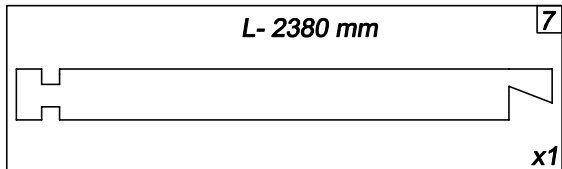
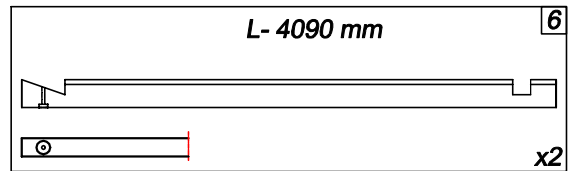
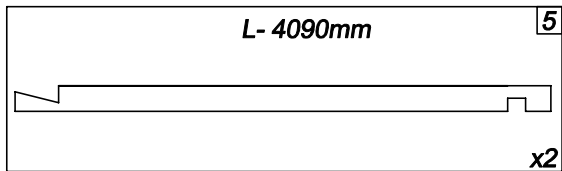
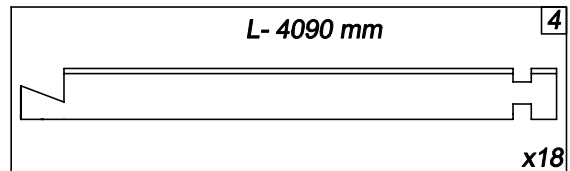
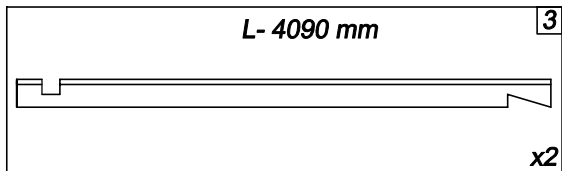
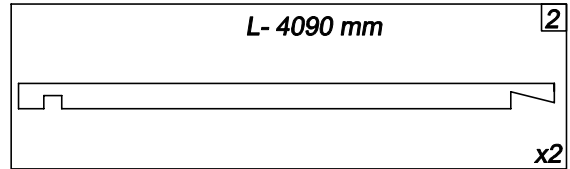
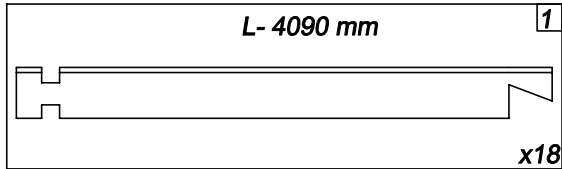
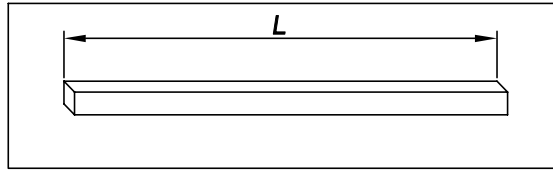

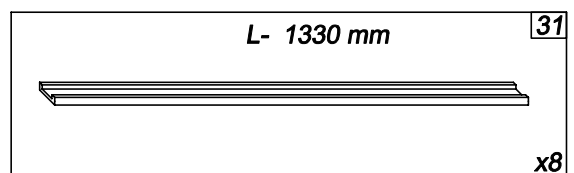
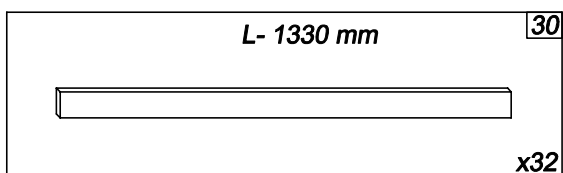
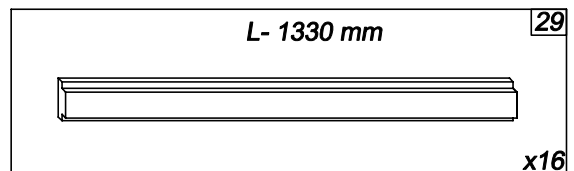
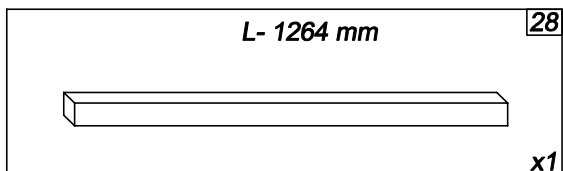
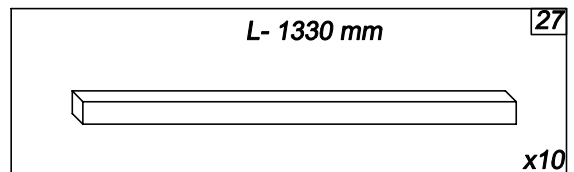
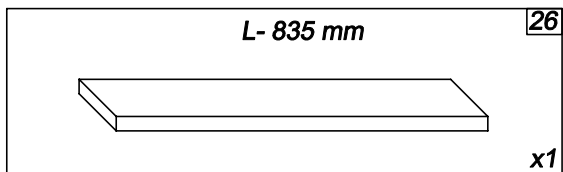
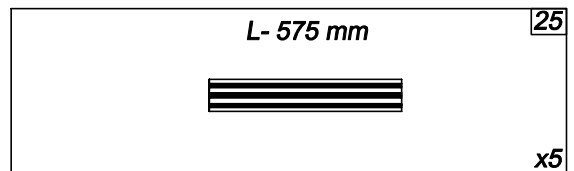
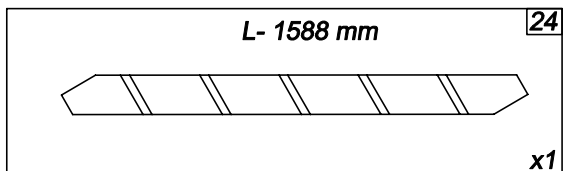
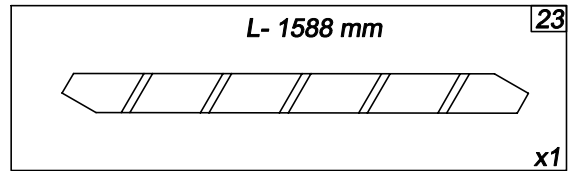
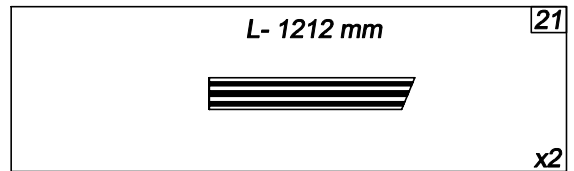
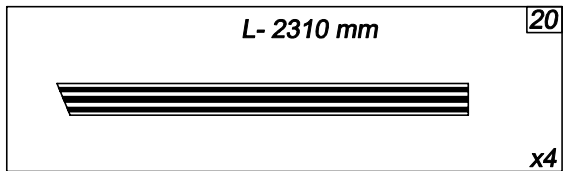
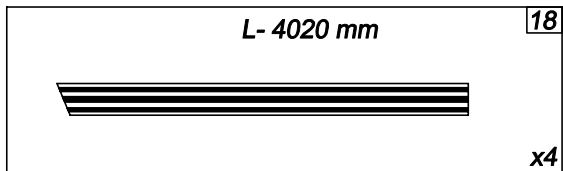
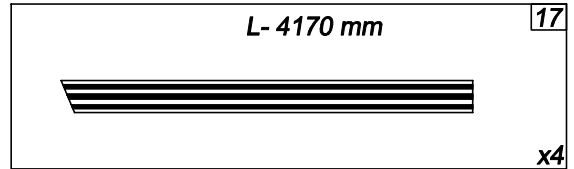
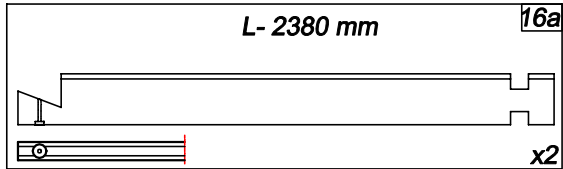
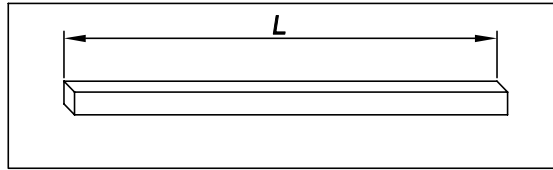

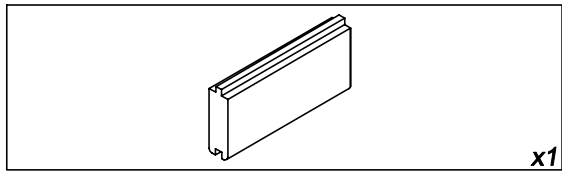
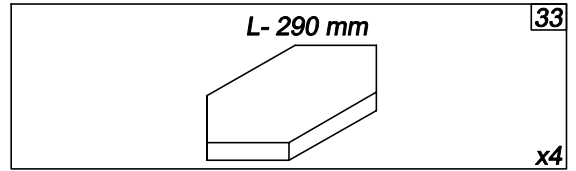
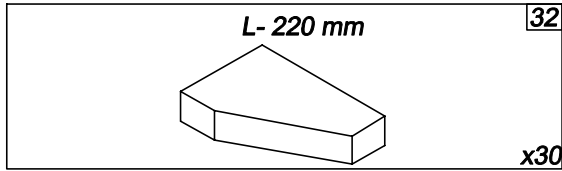
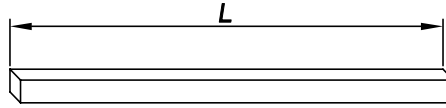

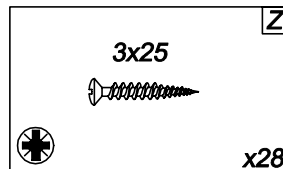
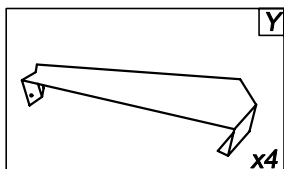
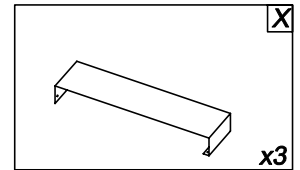
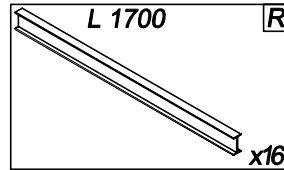
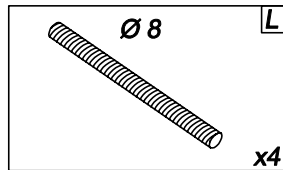
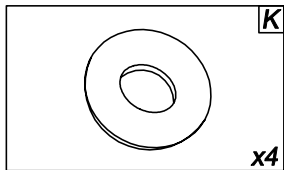
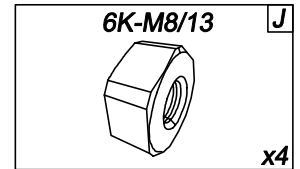
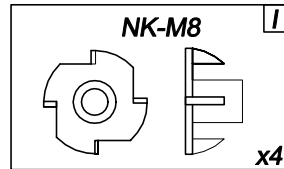
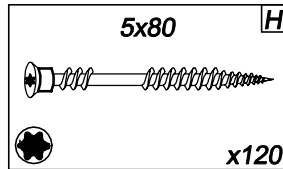
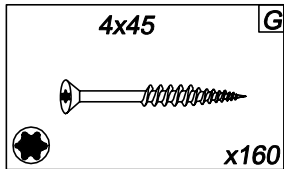
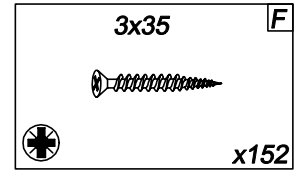
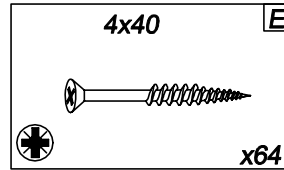
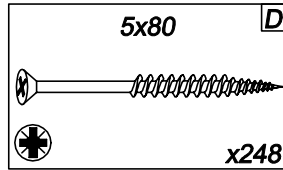
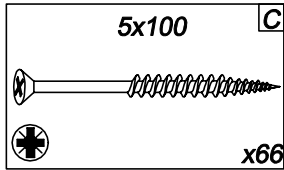
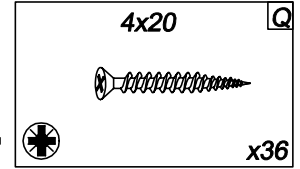
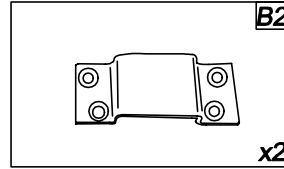
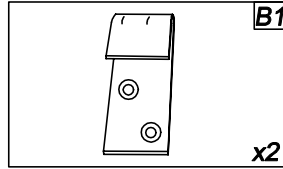
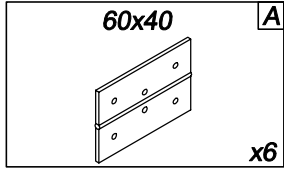

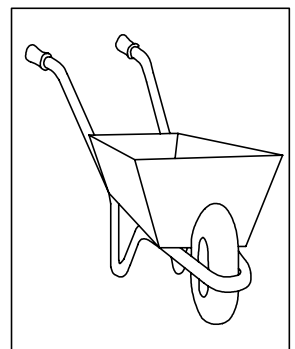
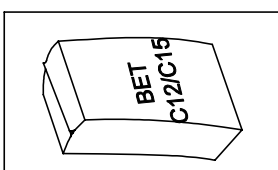
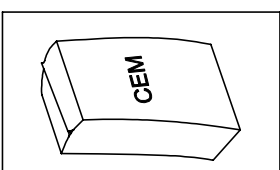
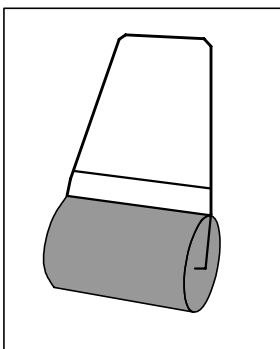
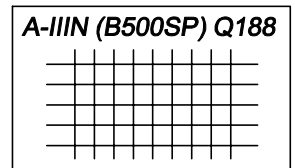
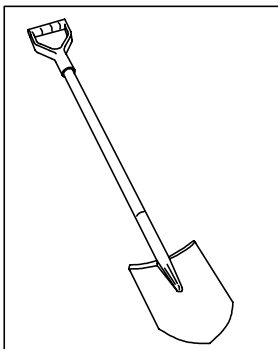
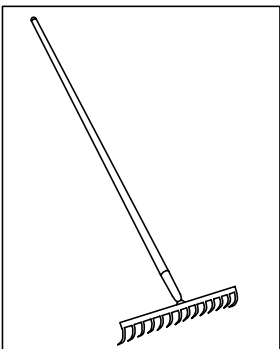
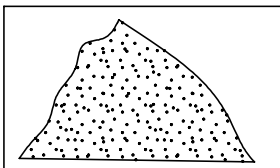
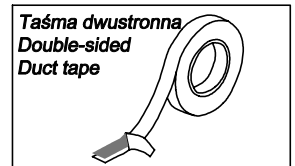
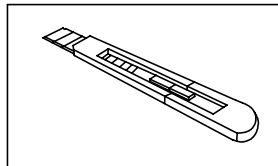
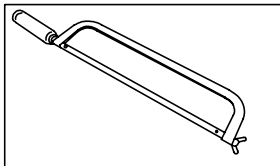
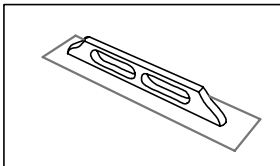
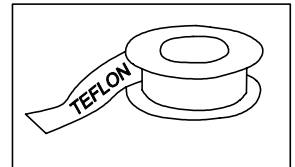
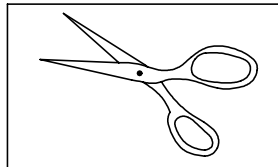
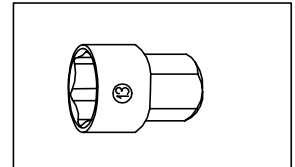
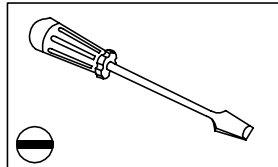
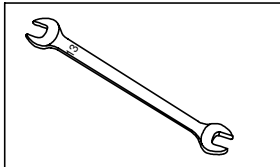
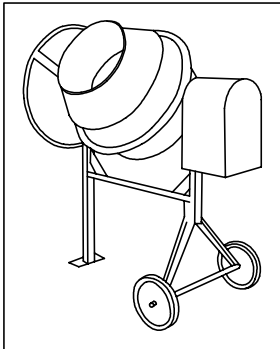
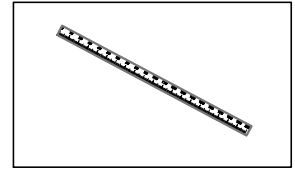
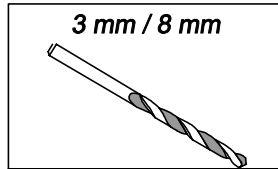
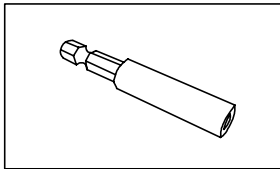
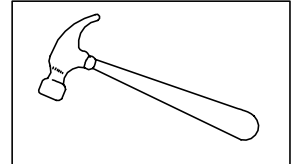
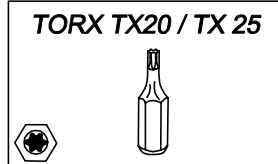
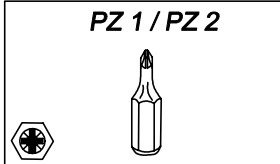
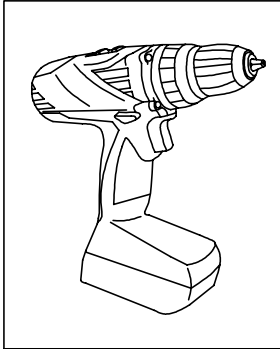
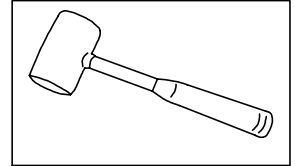
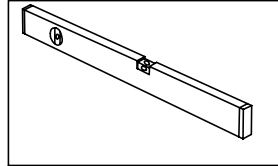
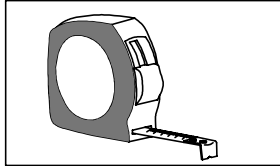
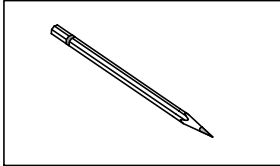

PL Podłoże

GB Ground

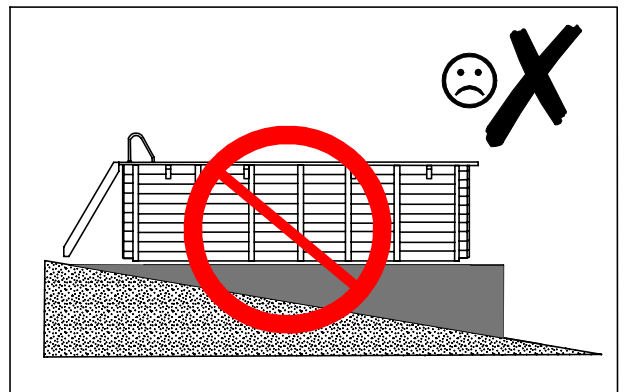
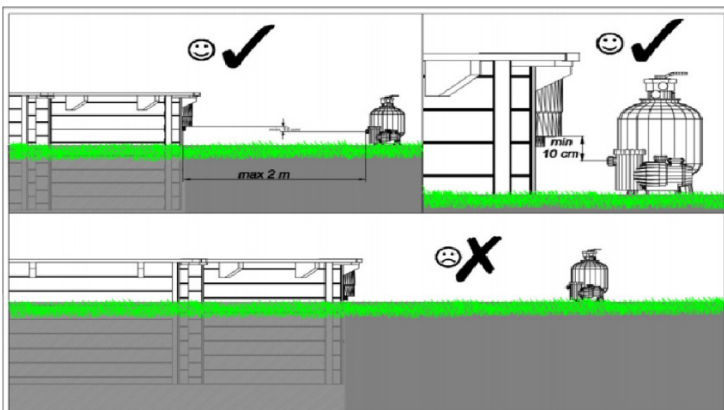
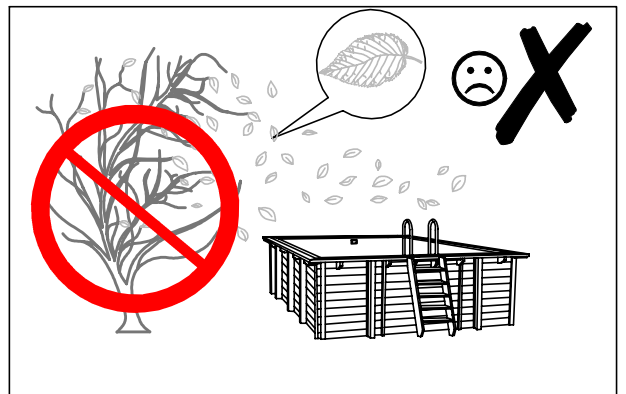
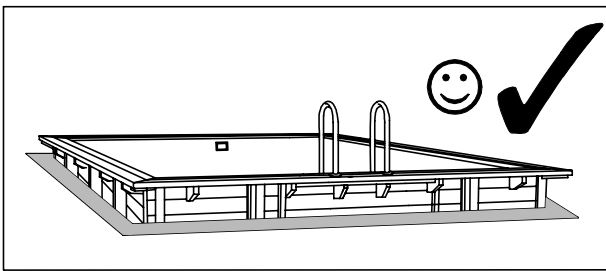
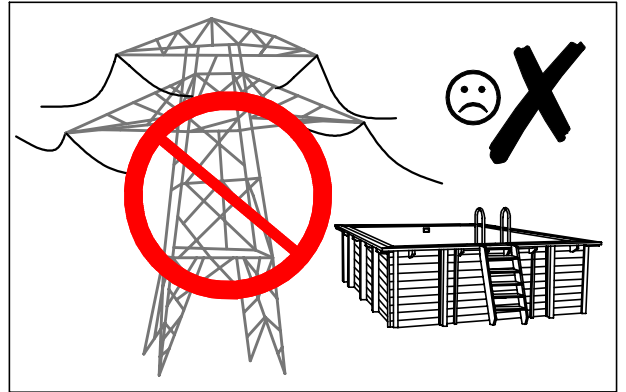
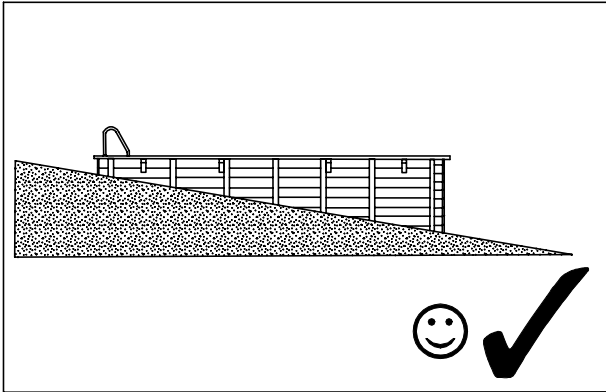
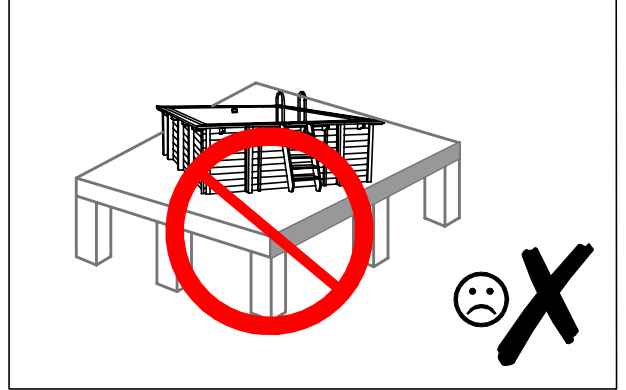
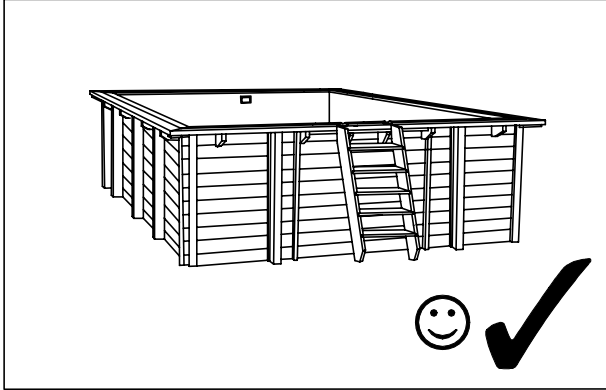



- 1 FUNDAMENT BASENU / FUNDATION
- 2 RURA DRENARSKA / DRAINAGE PIPE
- 3 PEŁCZERZYKOWA FOLIA FUNDAMENTOWA / FOUNDATION BUBBLE WRAP
- 4 ŻWIR / GRAVEL
- 5 GEOWŁÓKNINA OGRODOWA / GEOTEXTILE
- 6 GRUNT / GROUND

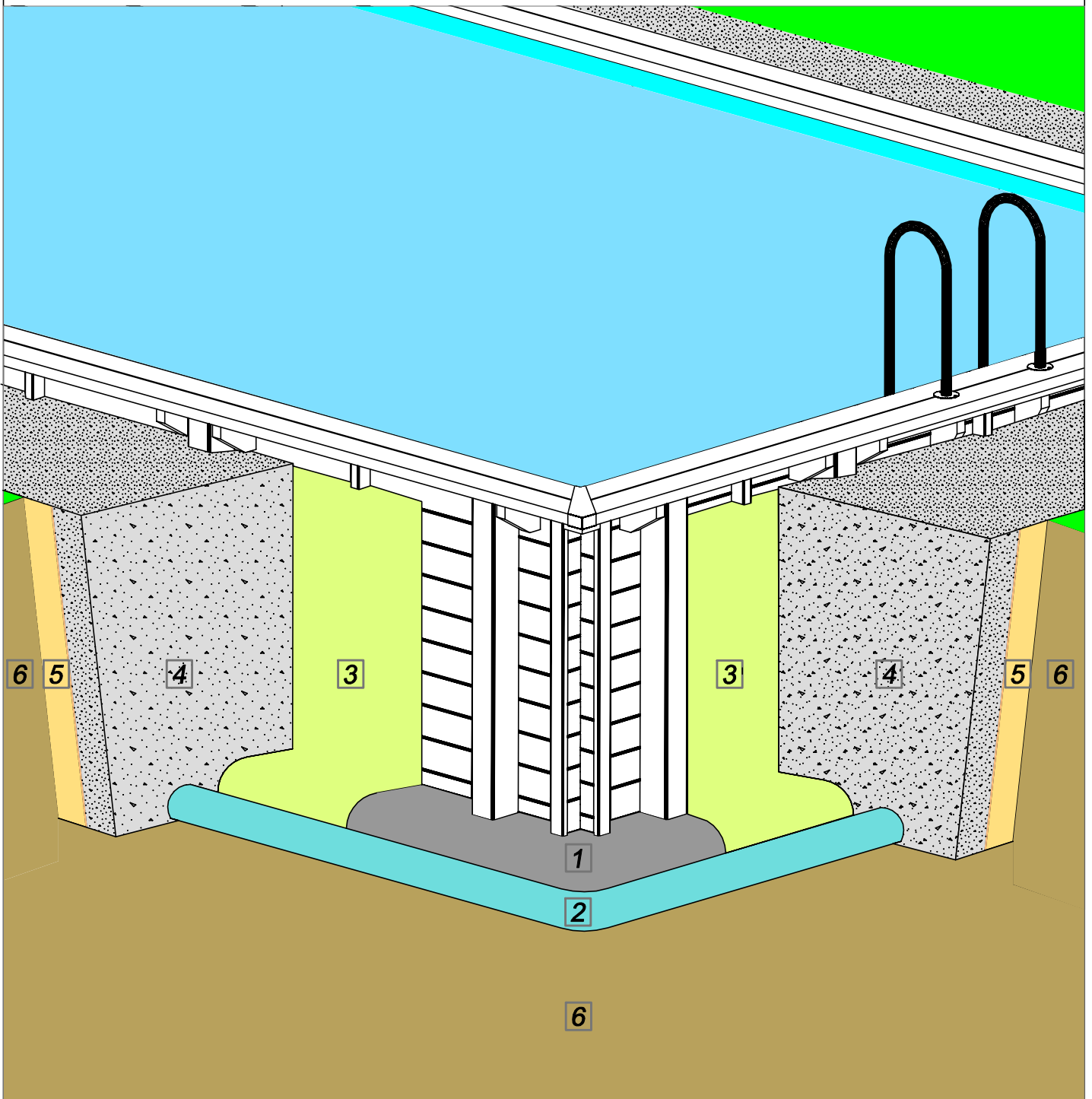

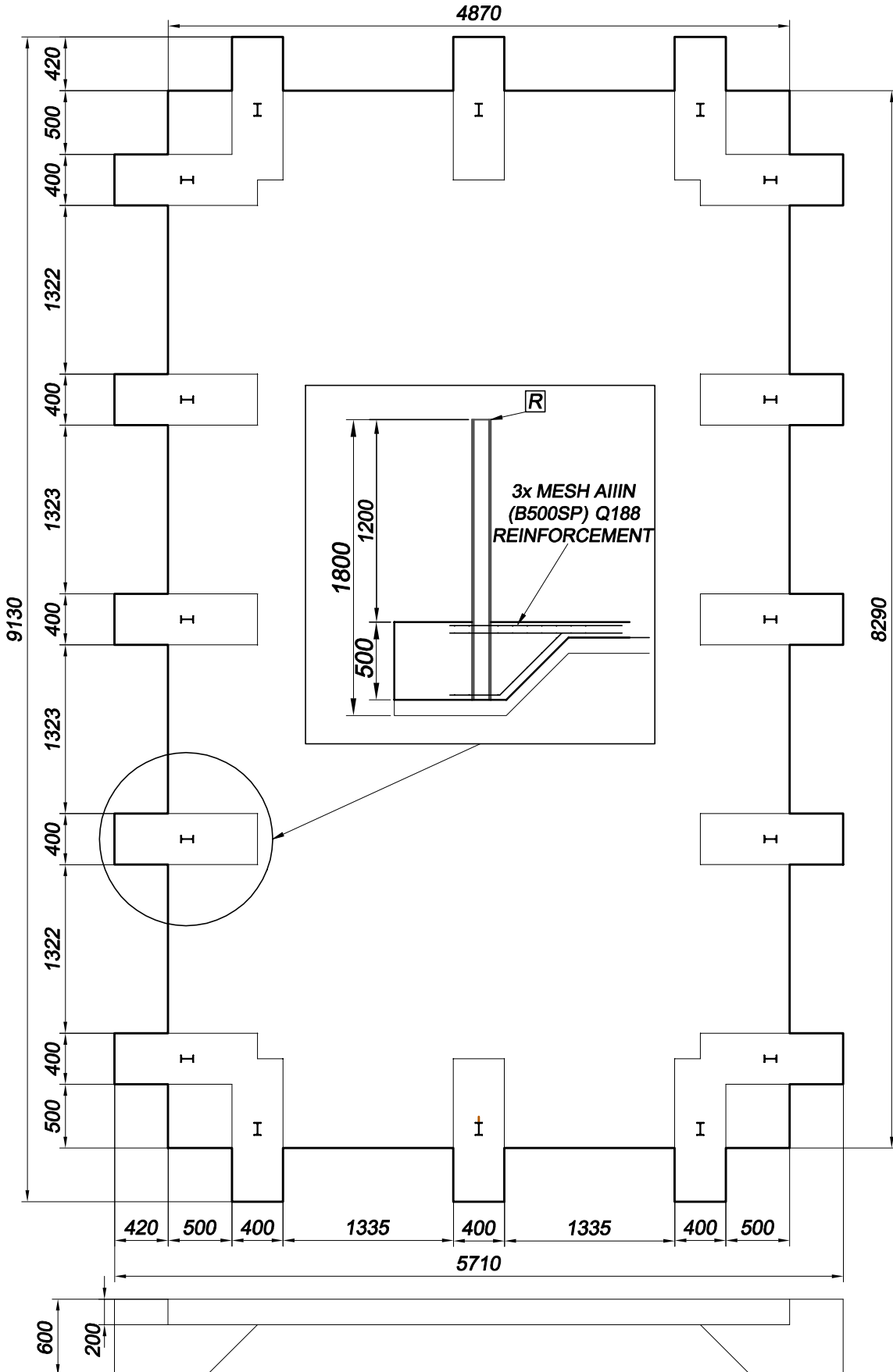

PL Podłoże

GB Ground

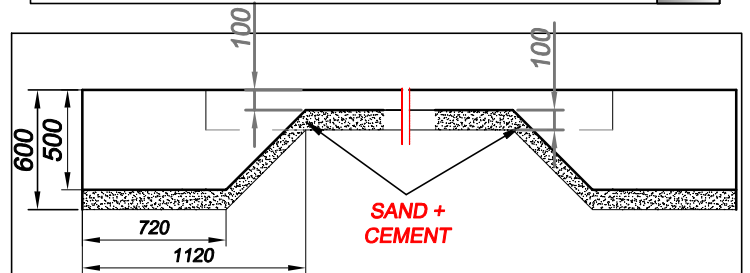
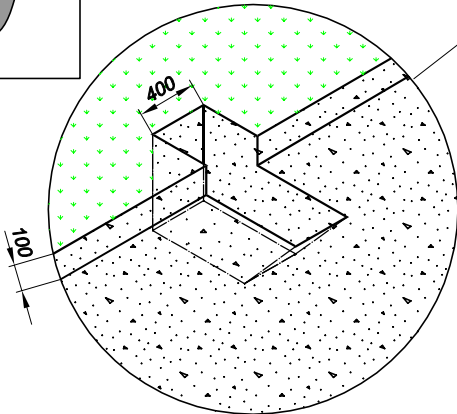
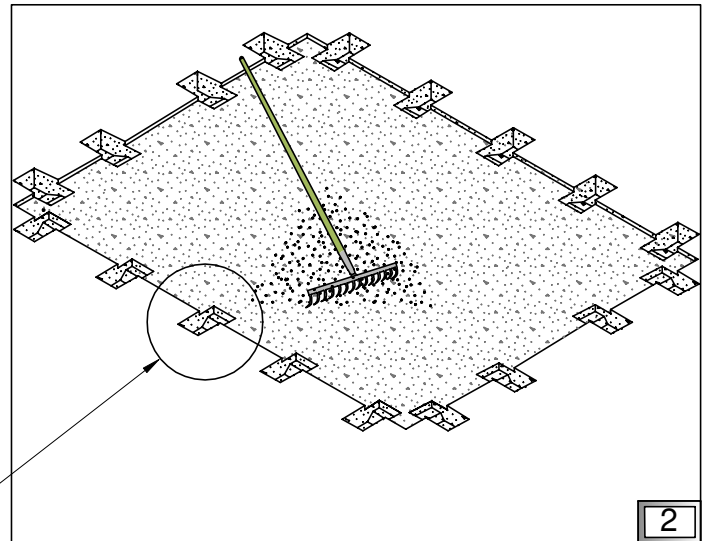
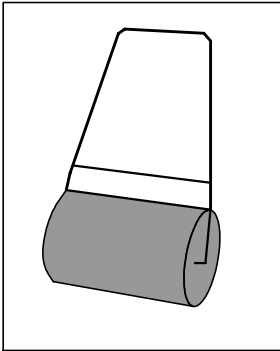
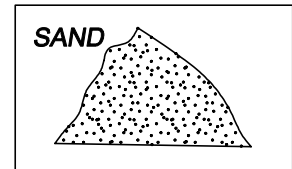
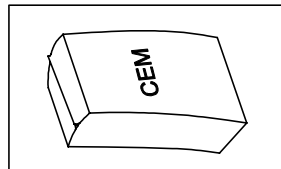
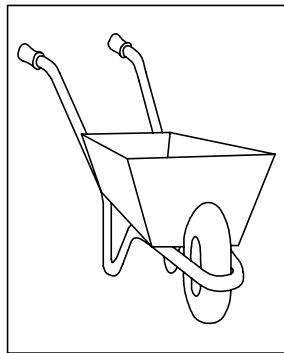
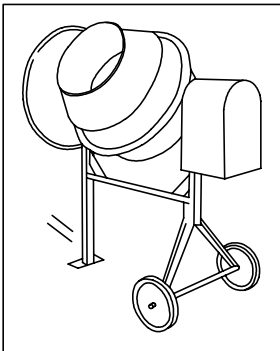
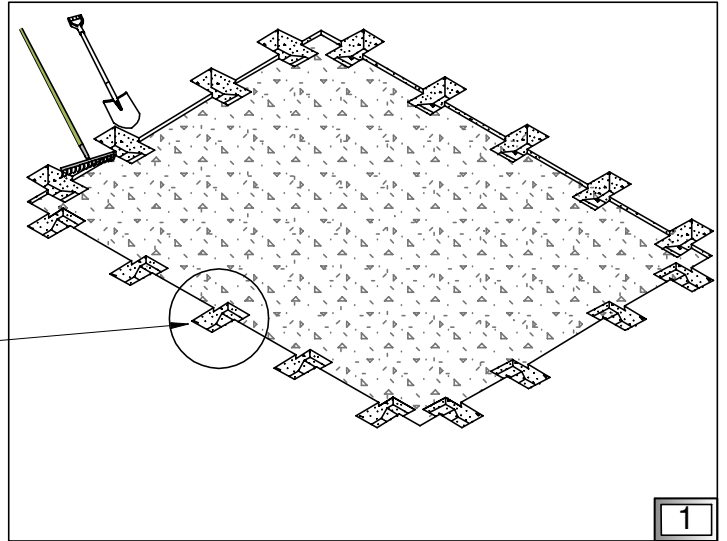
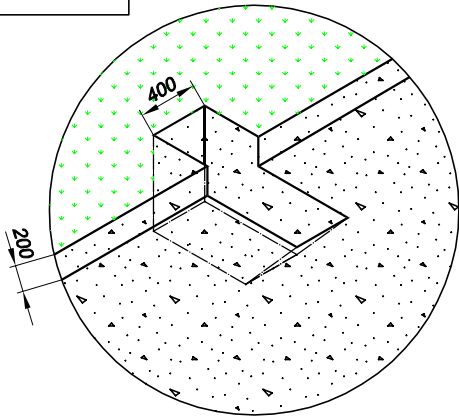
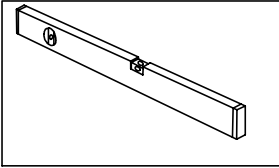

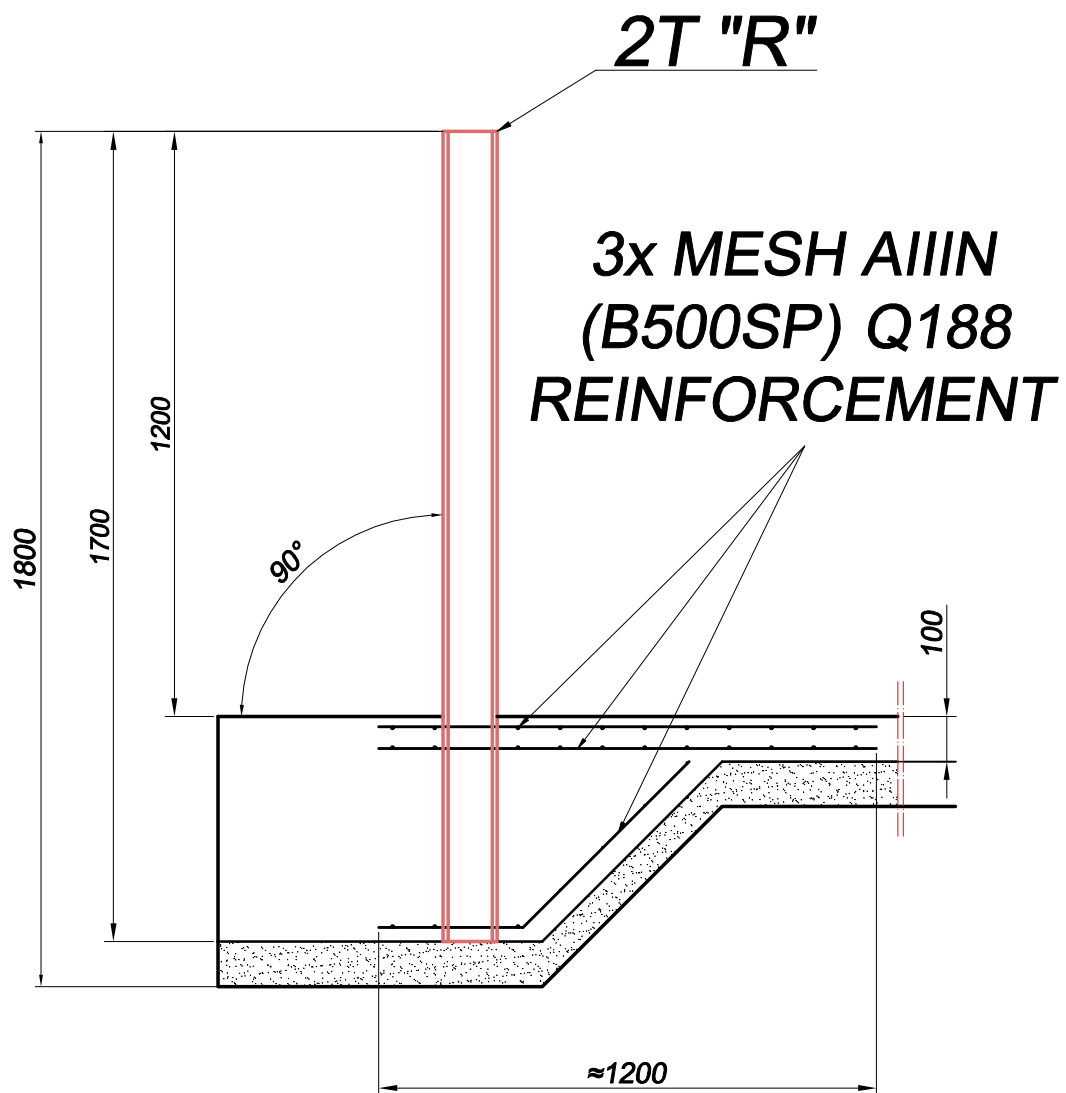

PL Podłozie

GB Ground

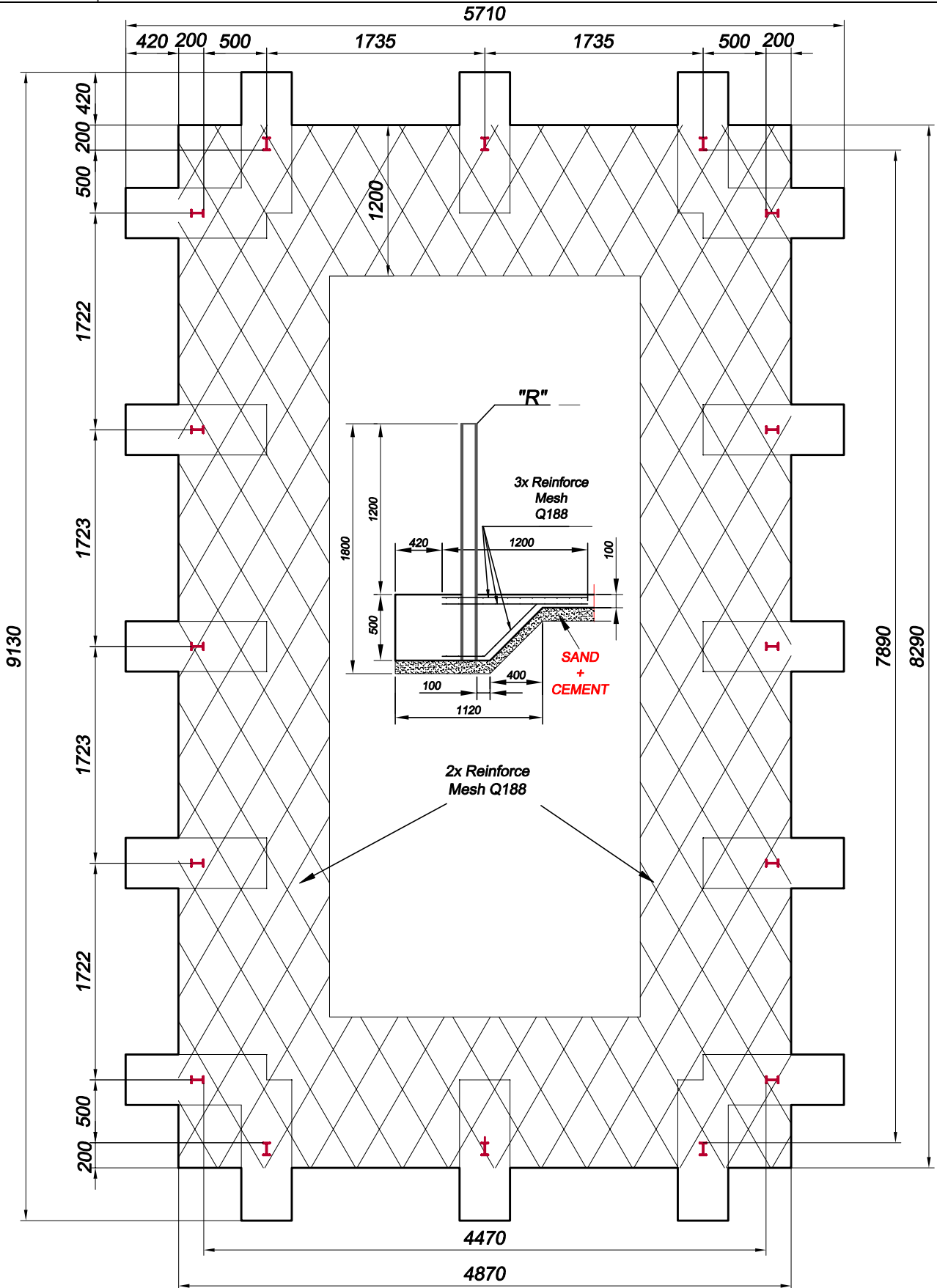

PL Podłoże

GB Ground

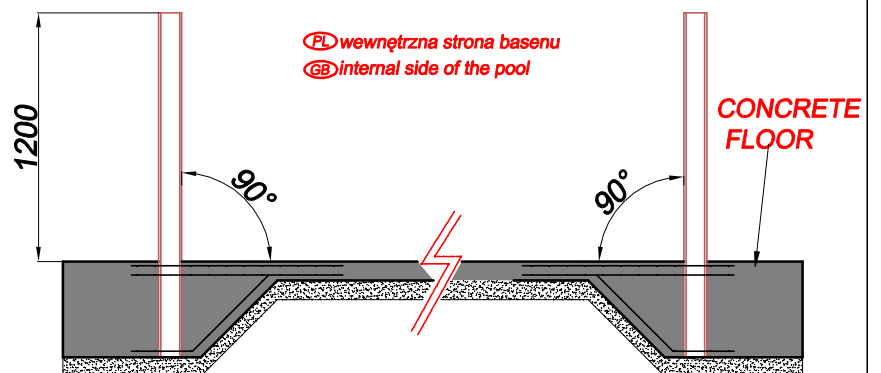
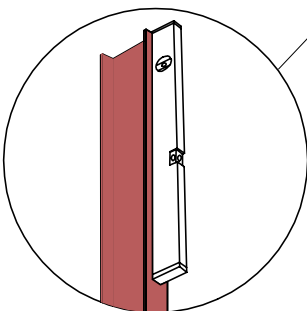
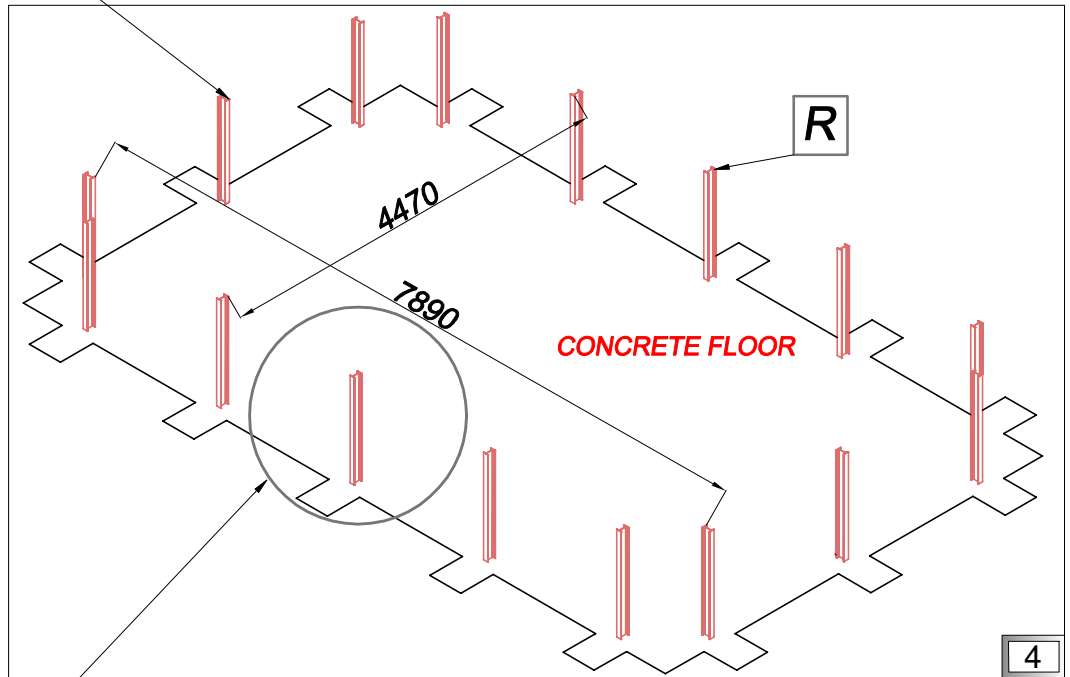
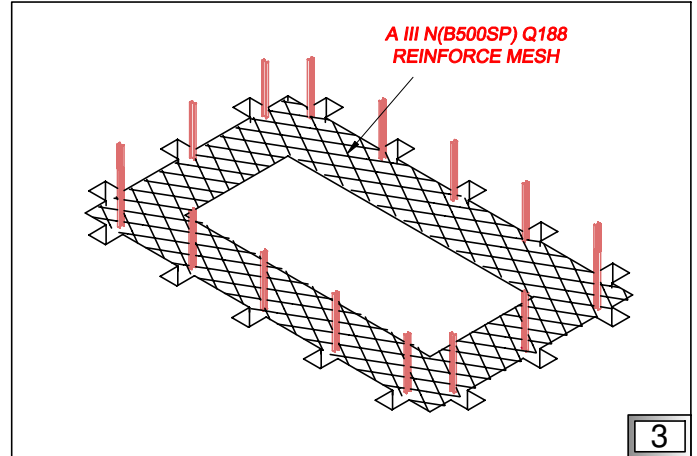
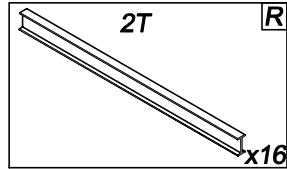
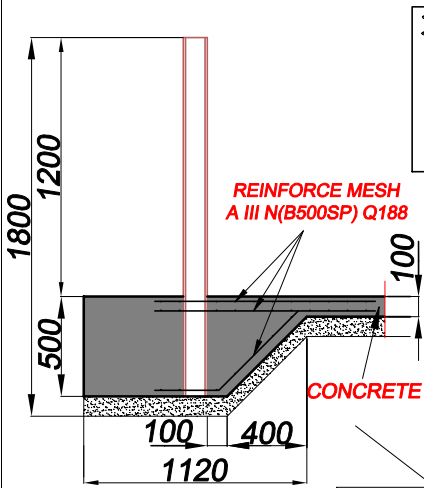
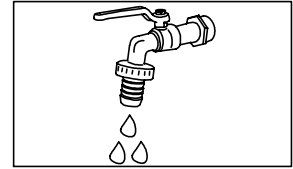
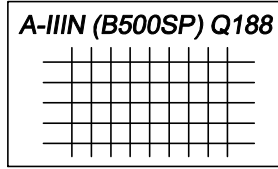
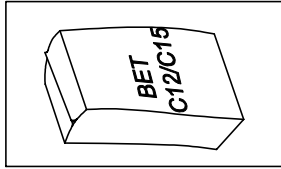

PL Podłozze

GB Ground

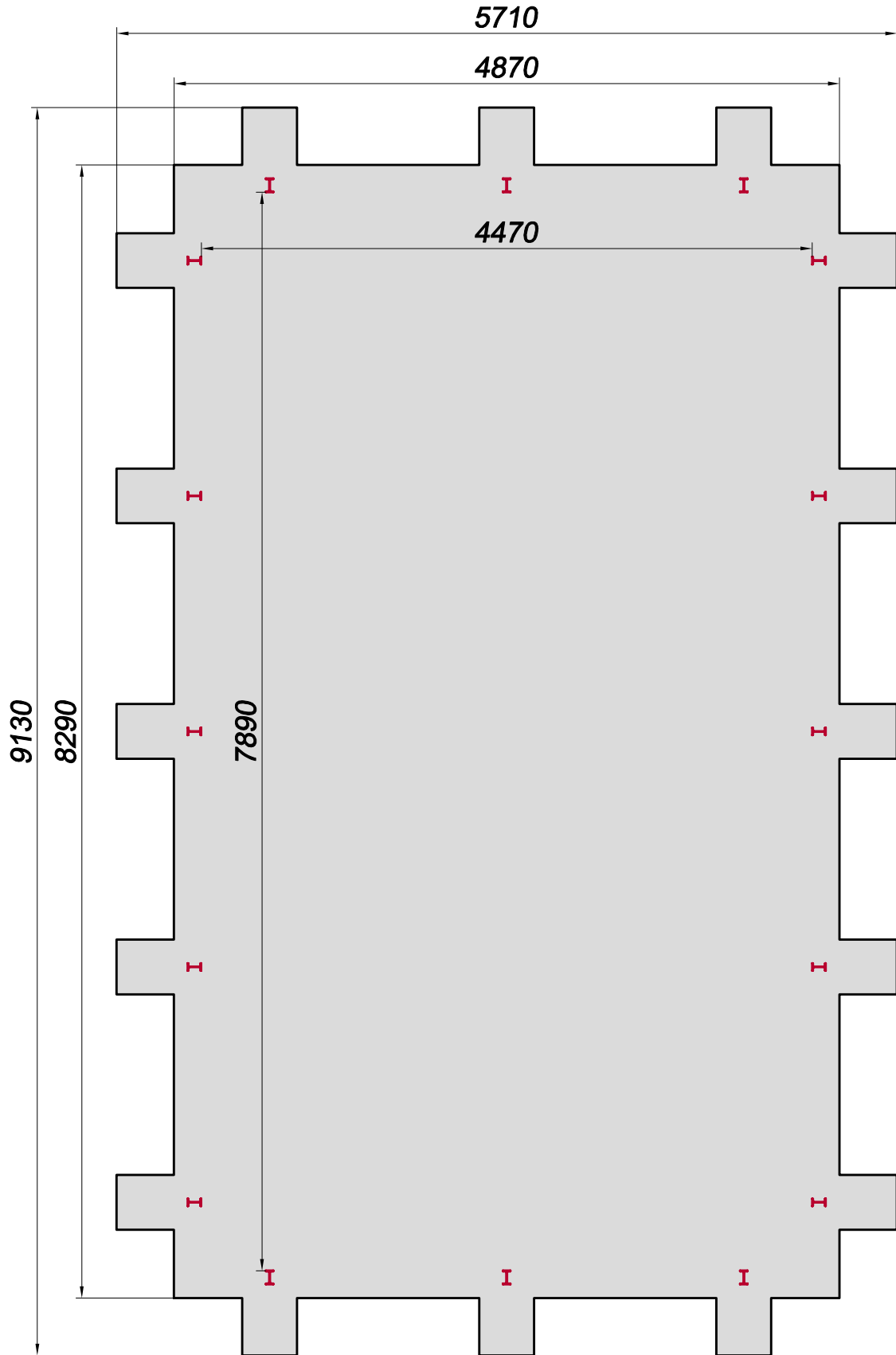



1

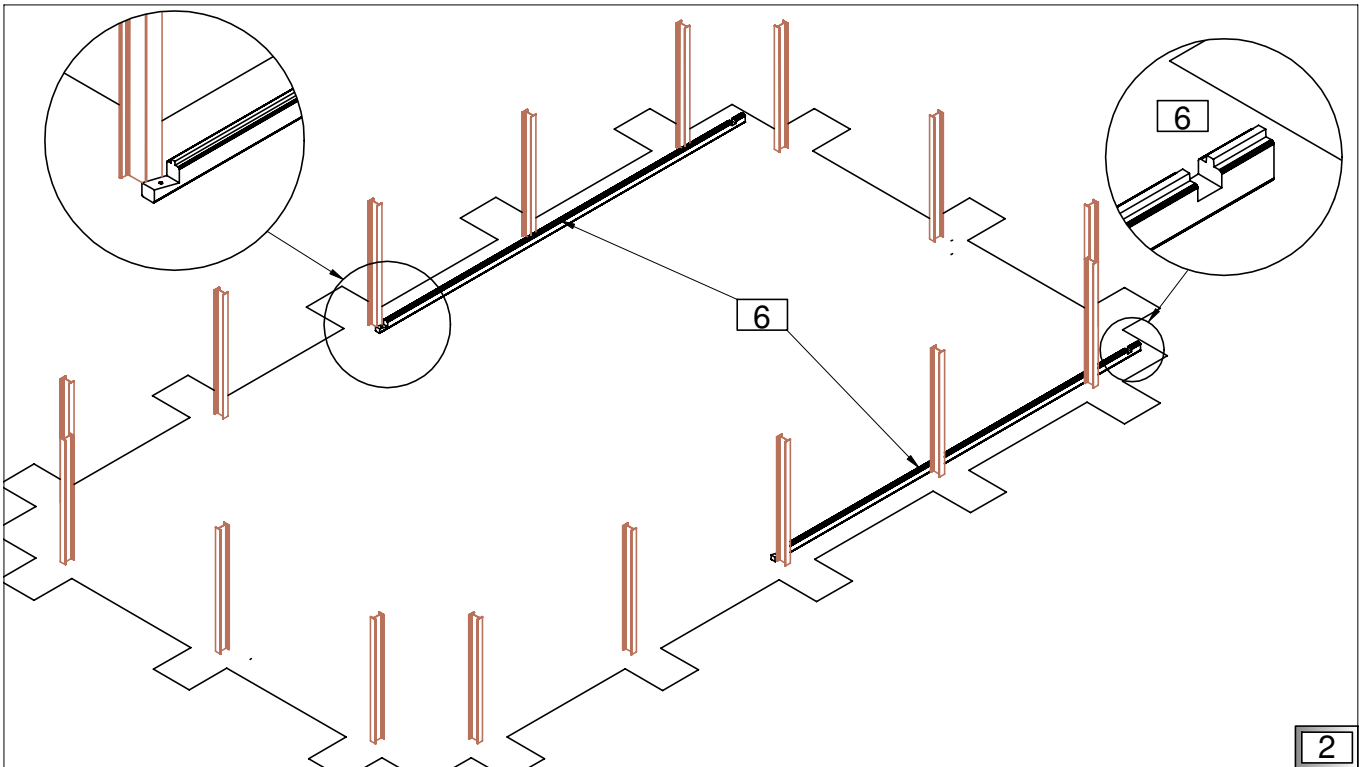
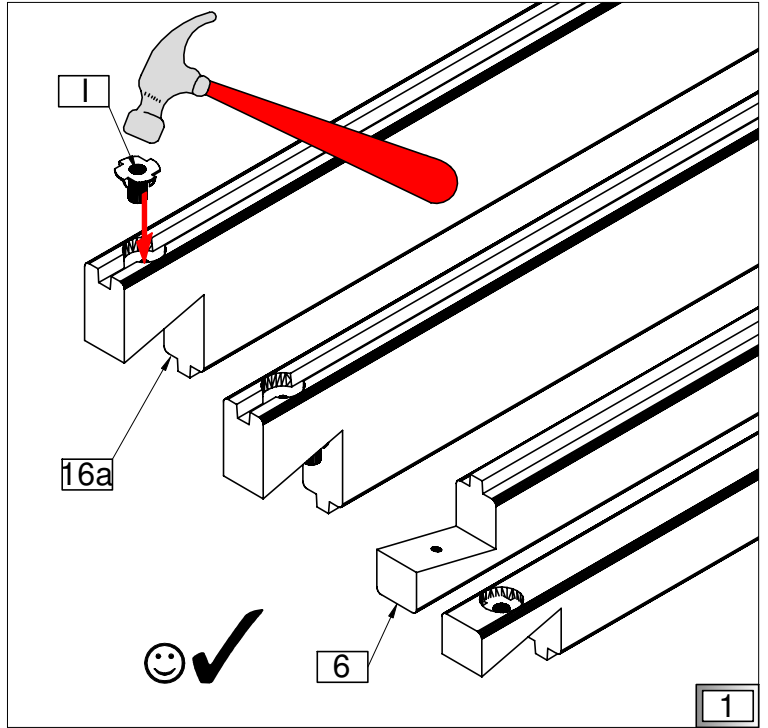
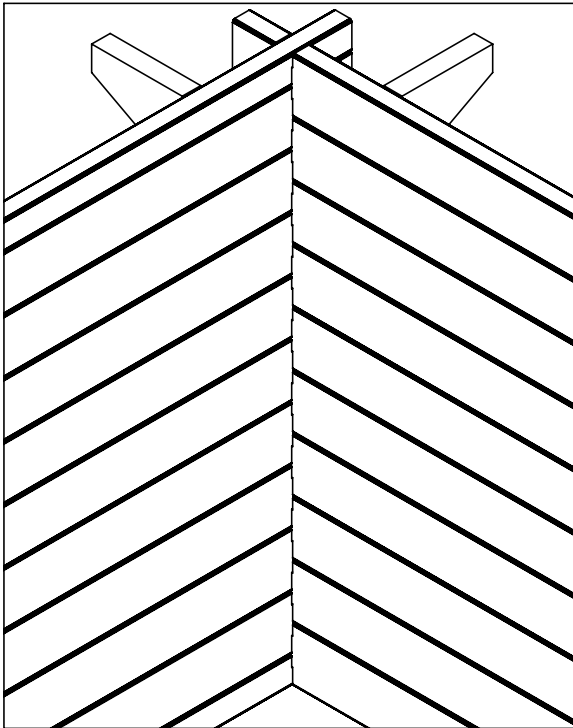
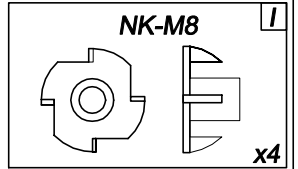
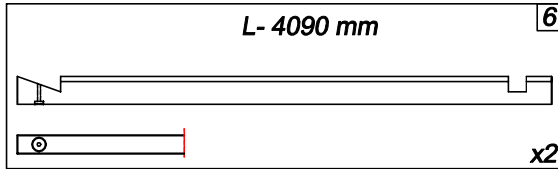
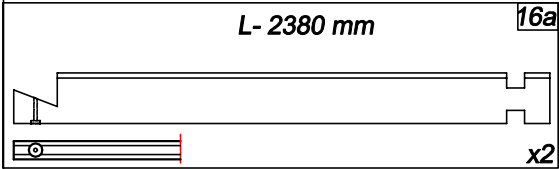

2

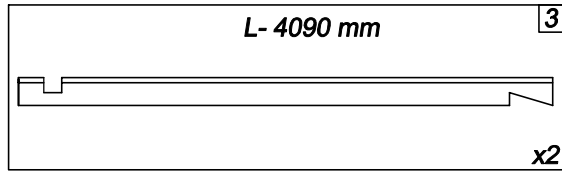
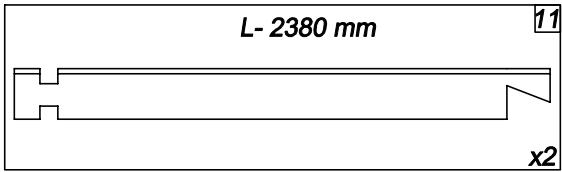

1

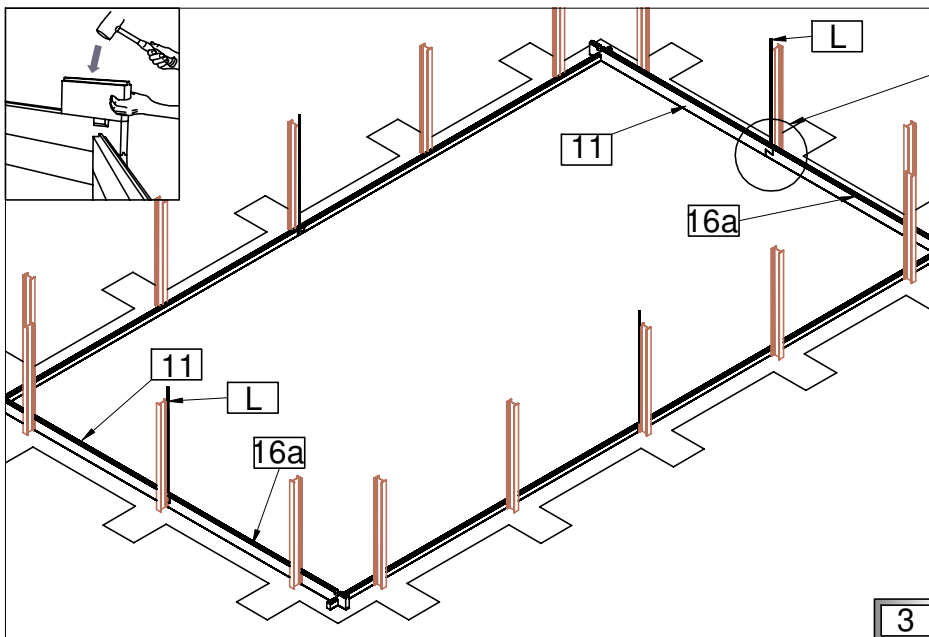
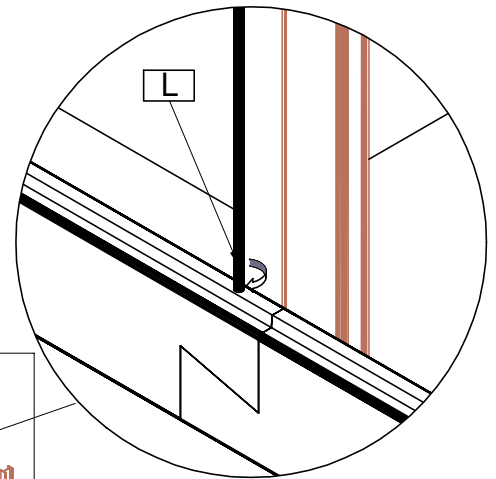
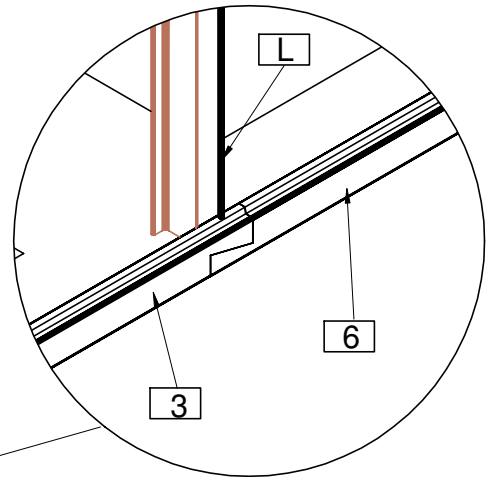
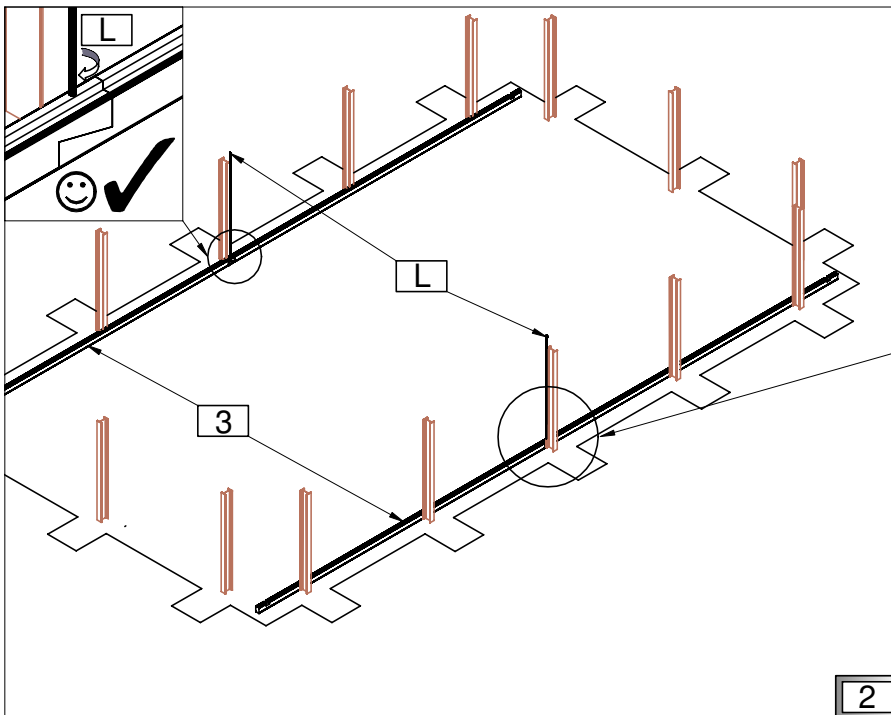
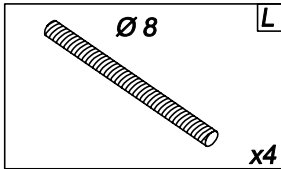

3

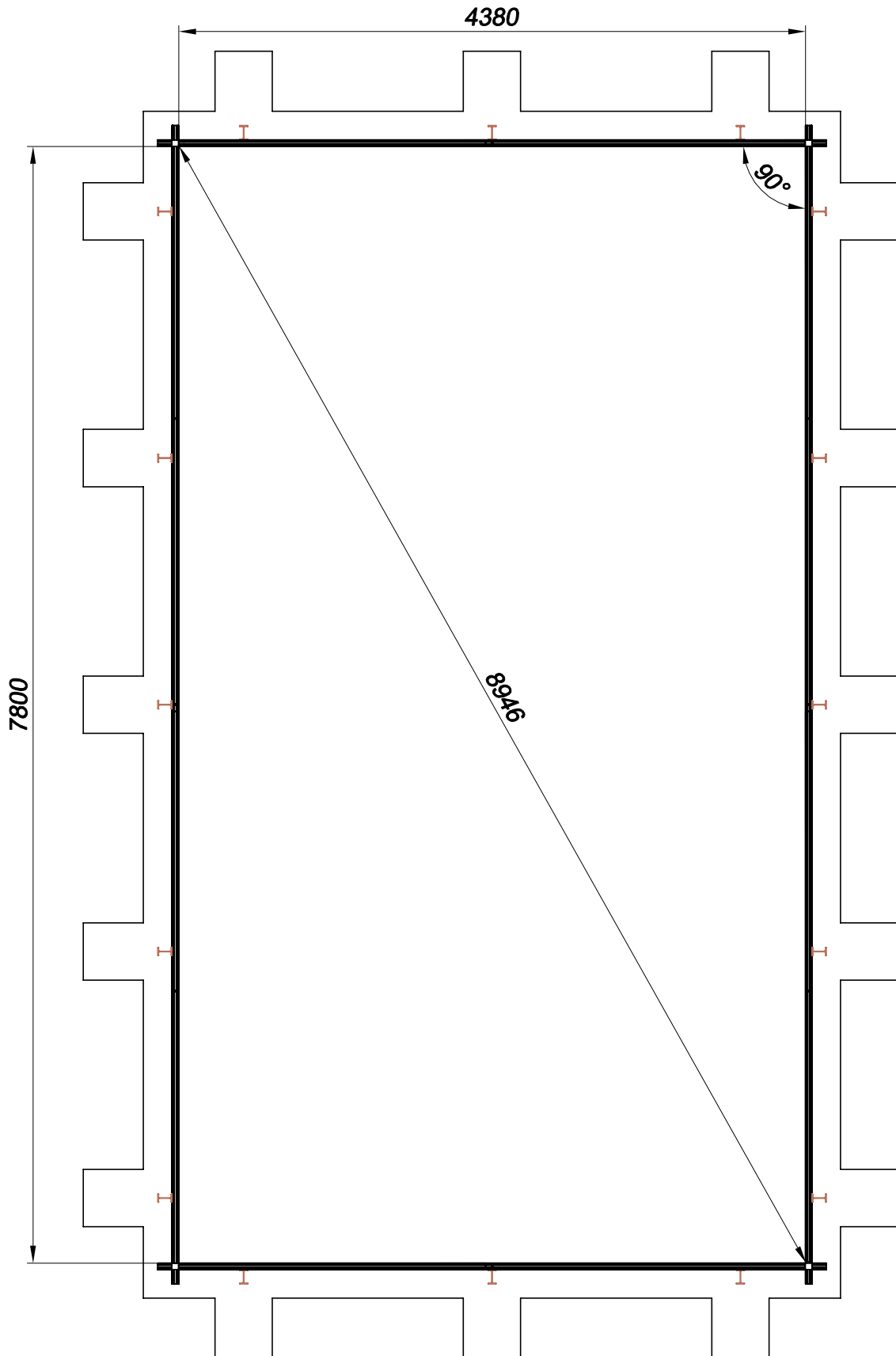

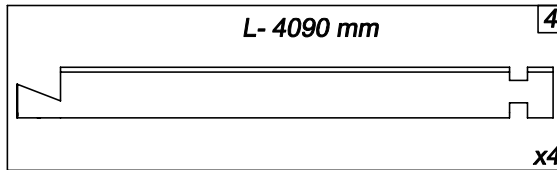
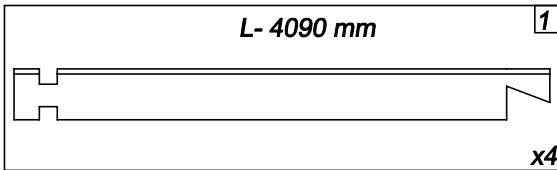

II-III

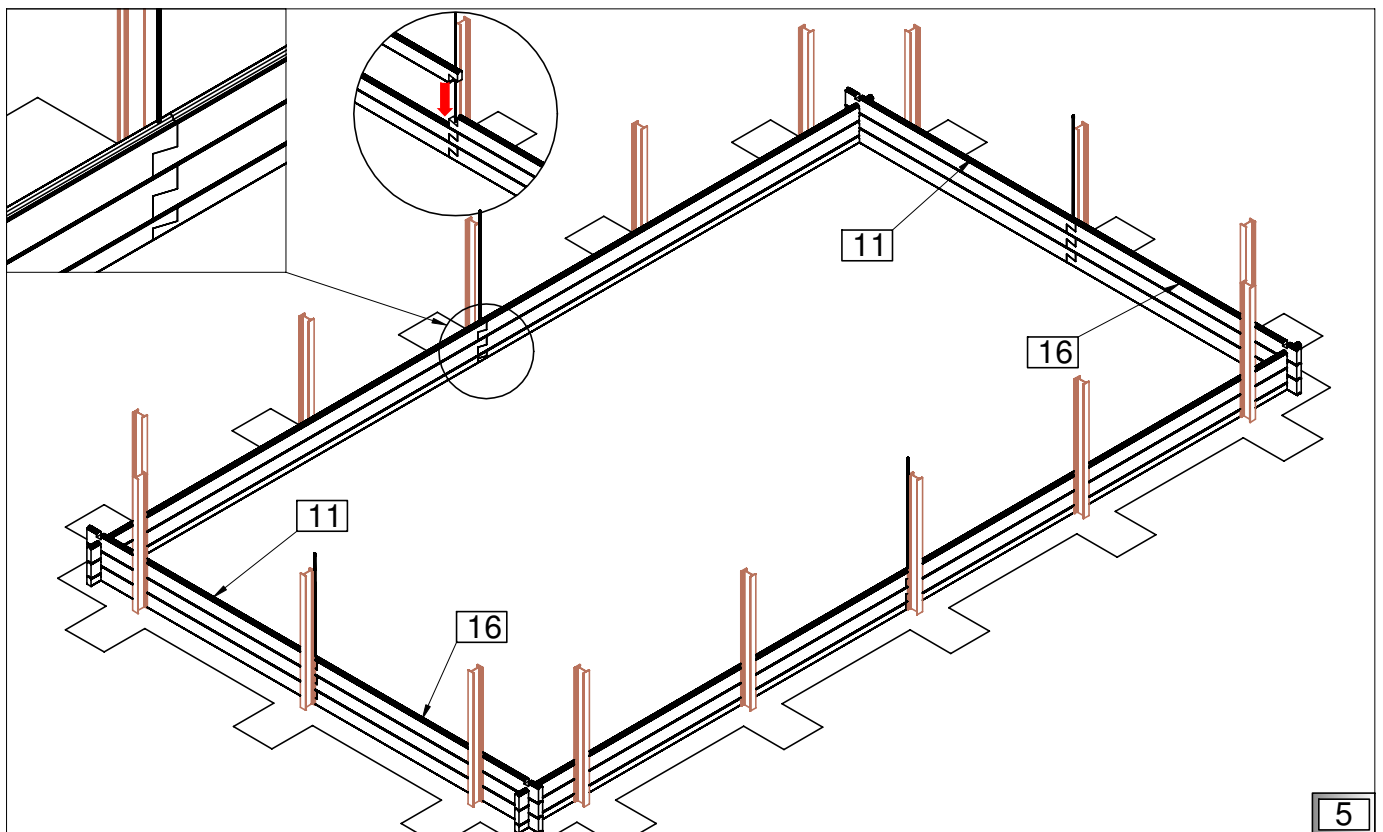
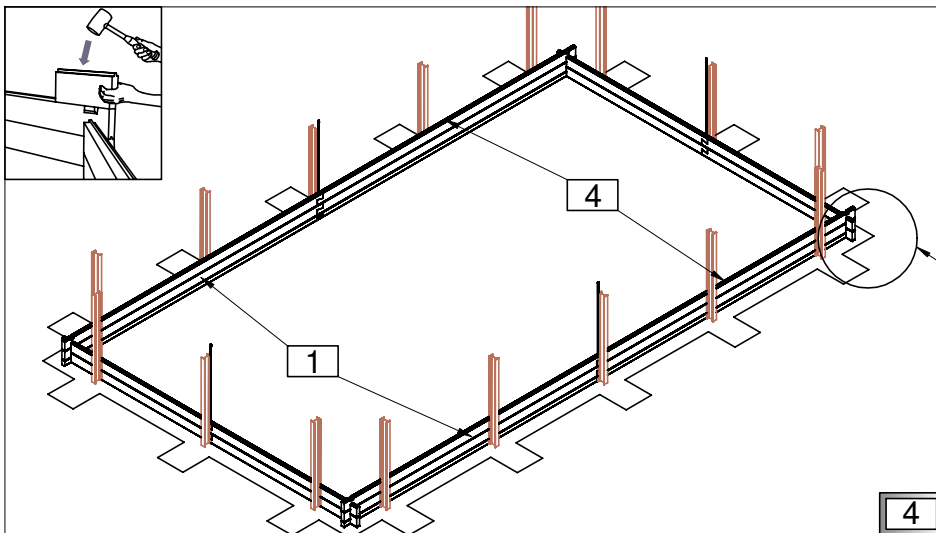
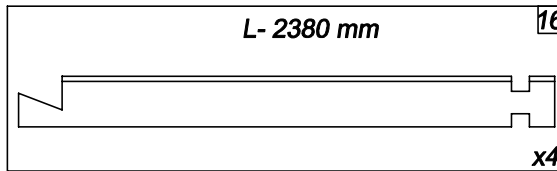
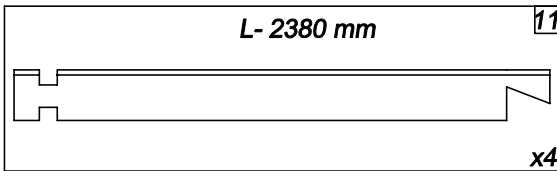



IV

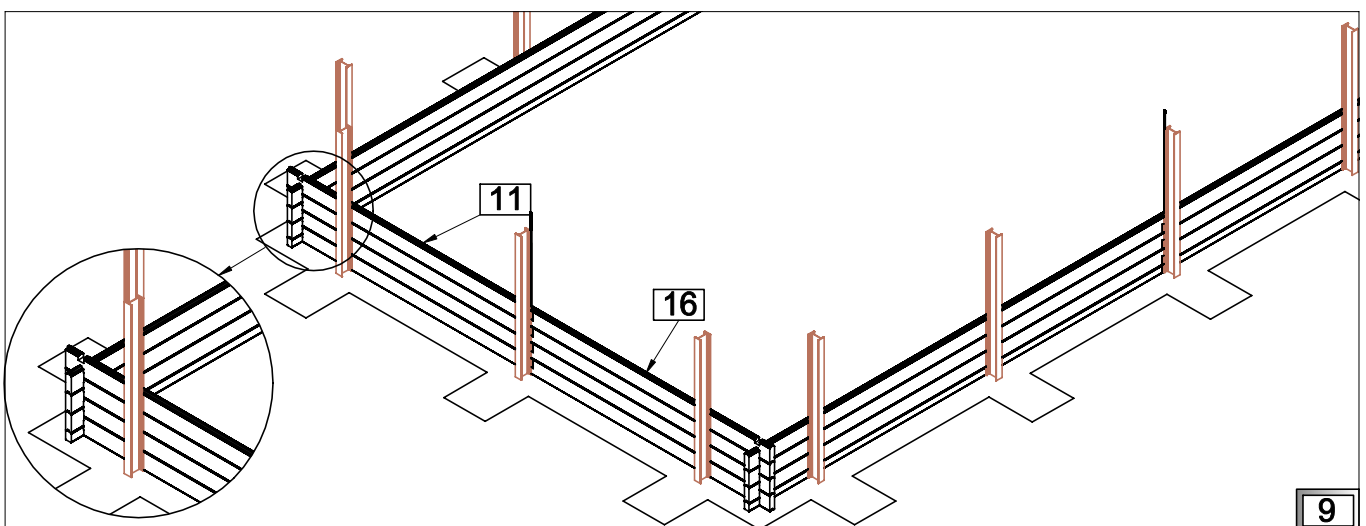
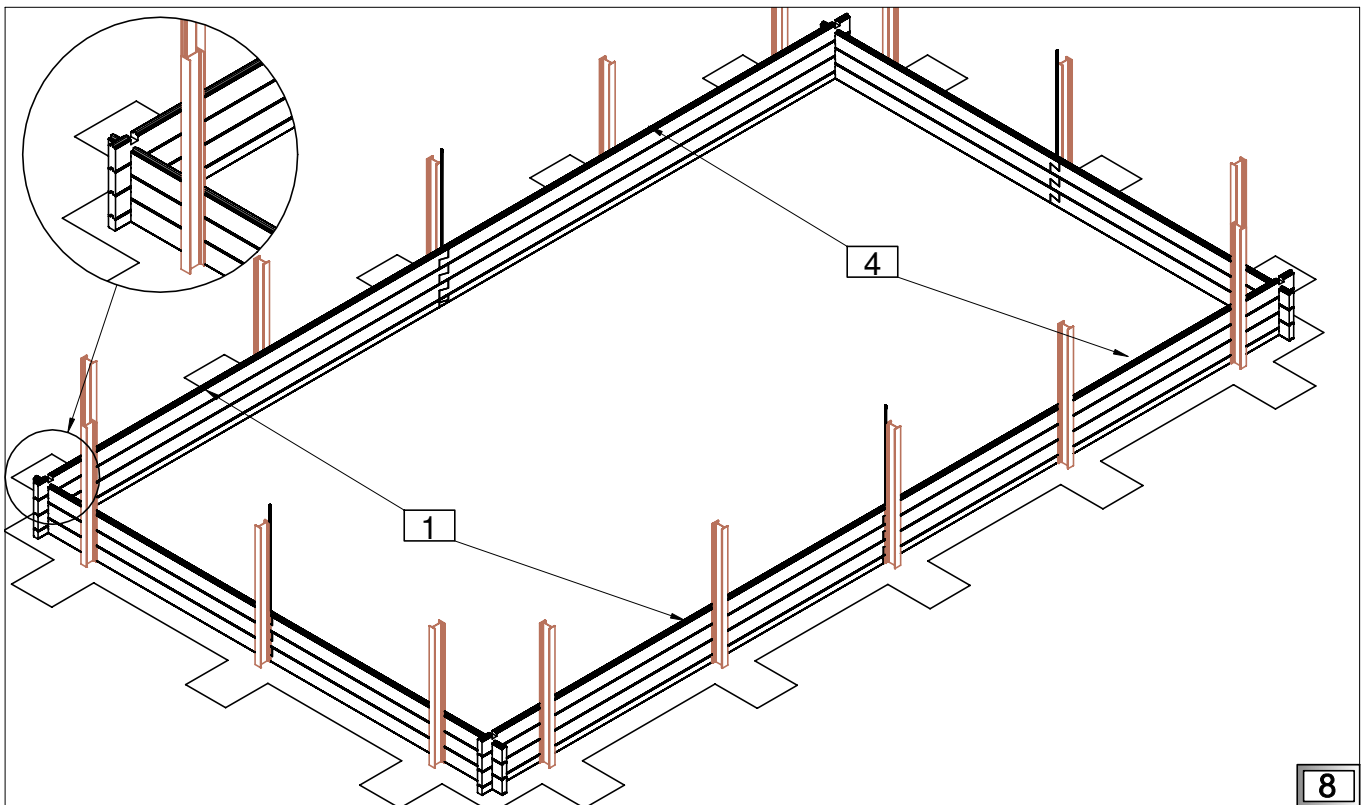
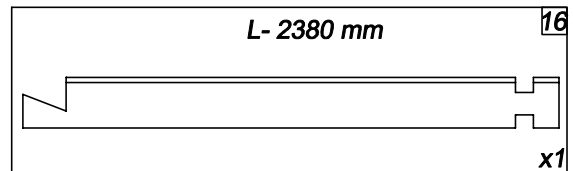
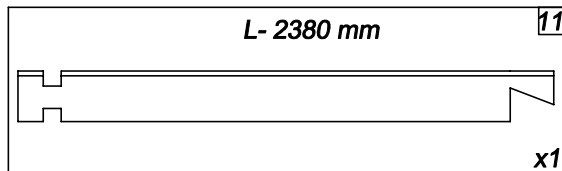
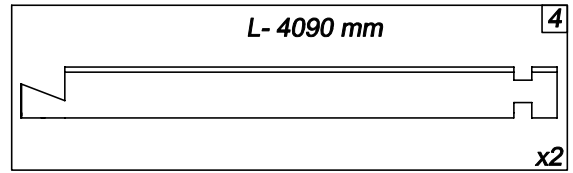
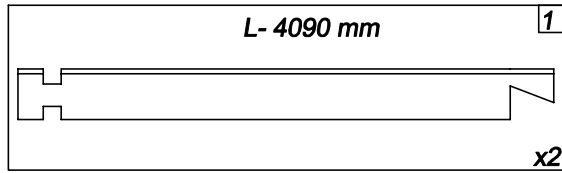



IV

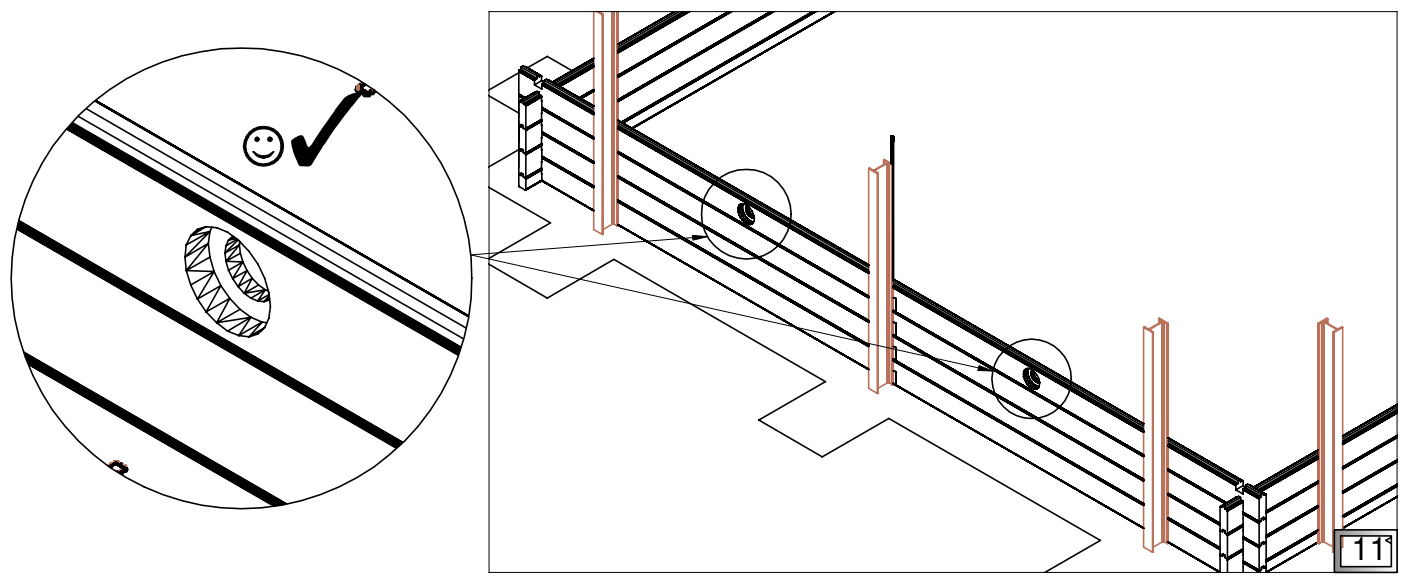
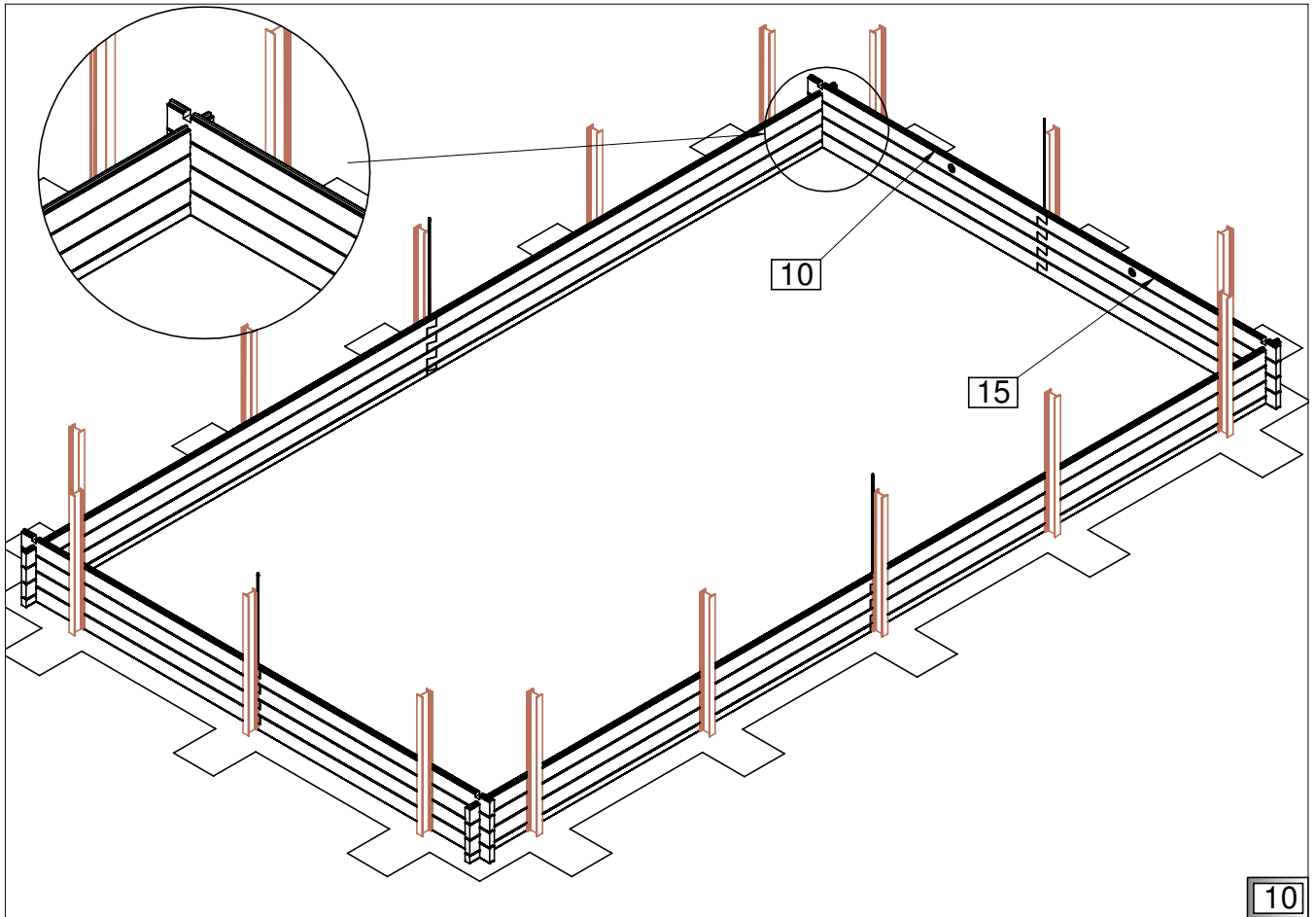
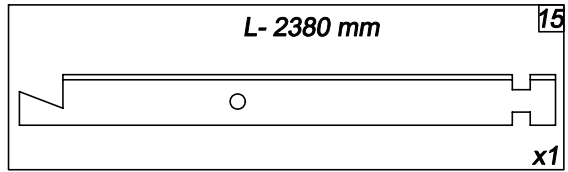

PL Struktura drewniana

GB Wooden structure

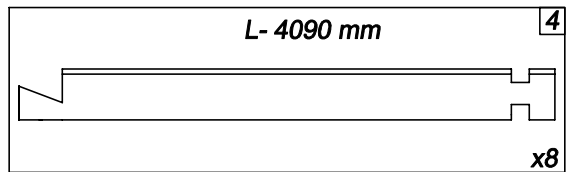
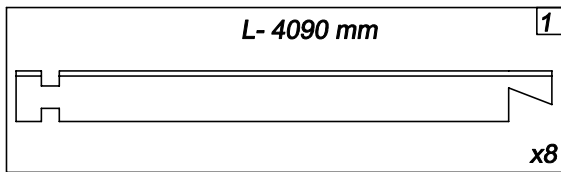

V-VIII

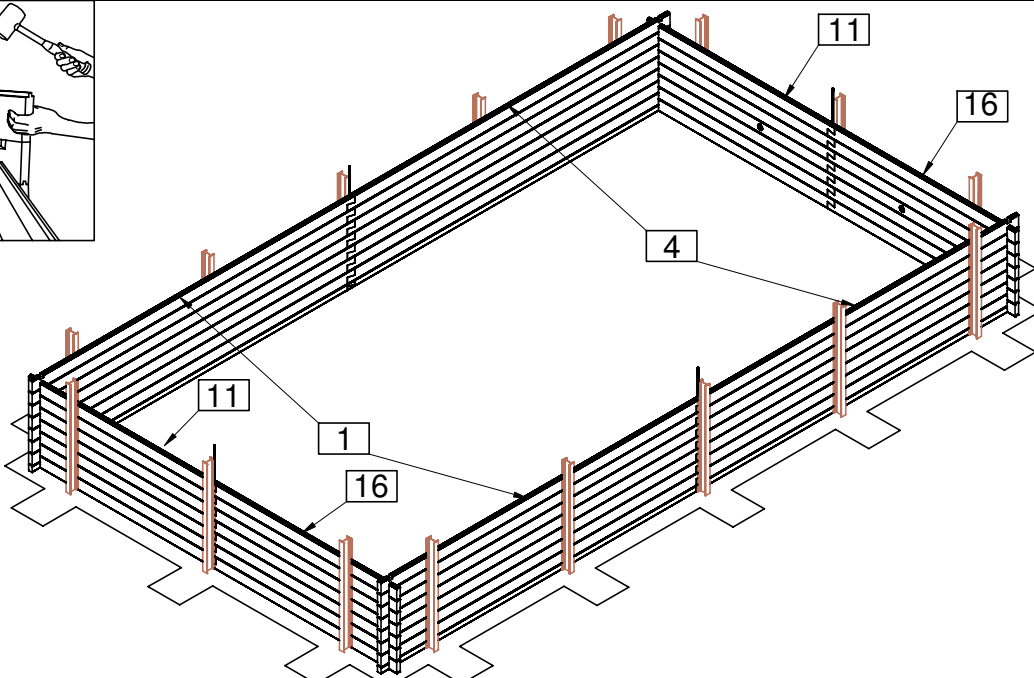
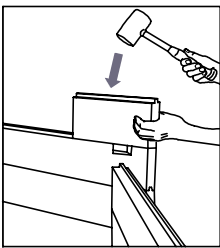
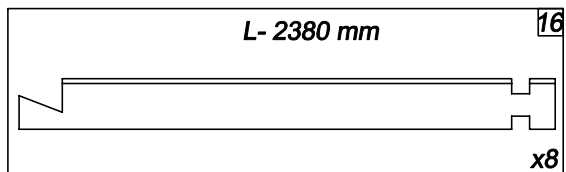
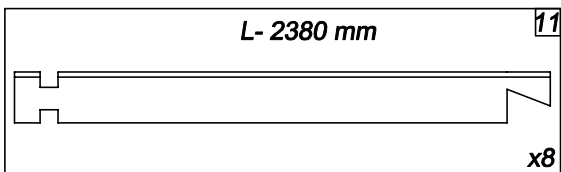

12

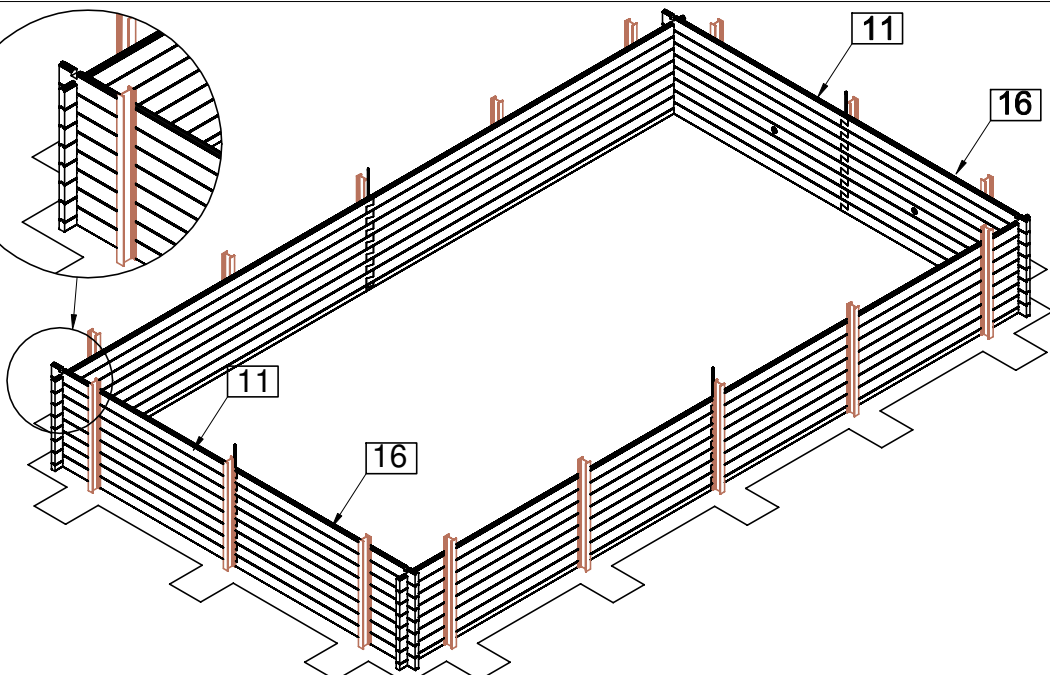
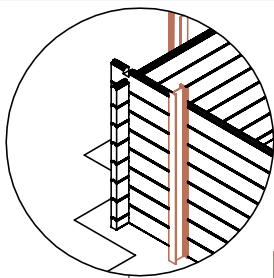

13

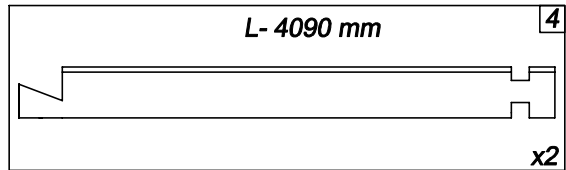
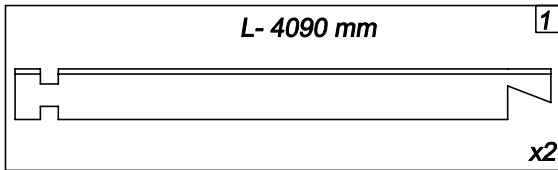

IX

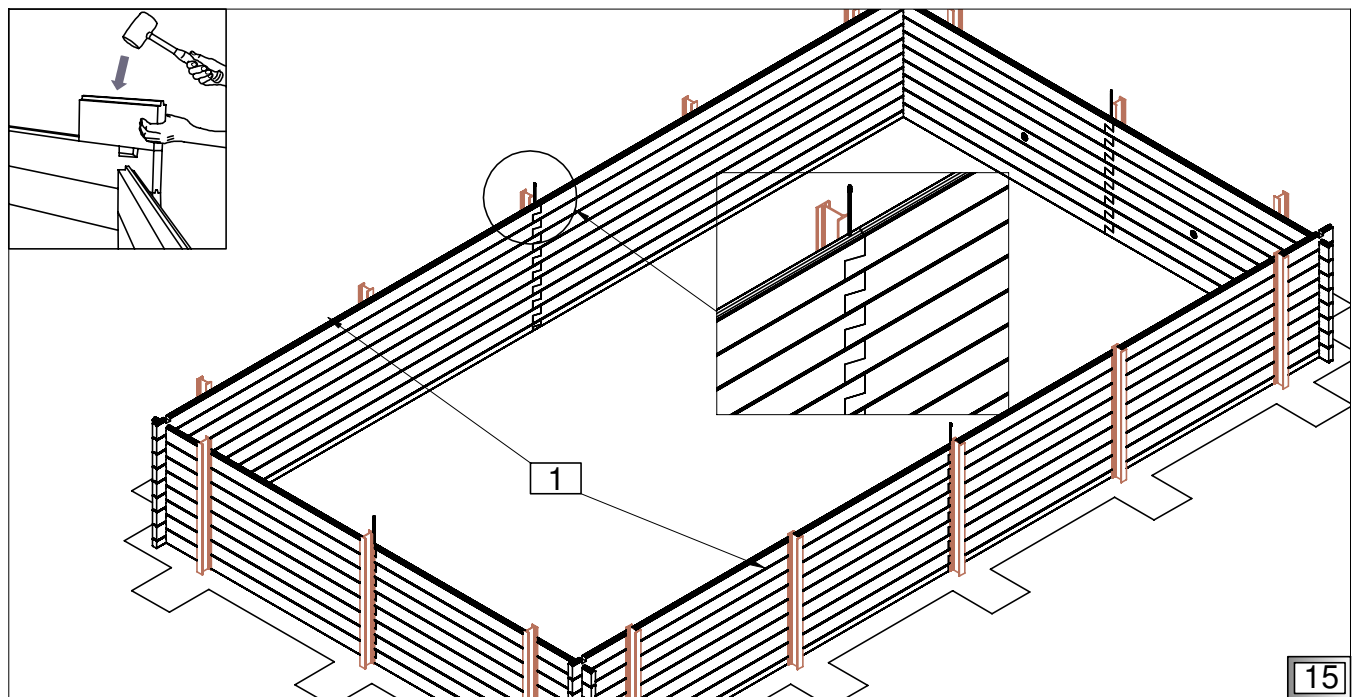
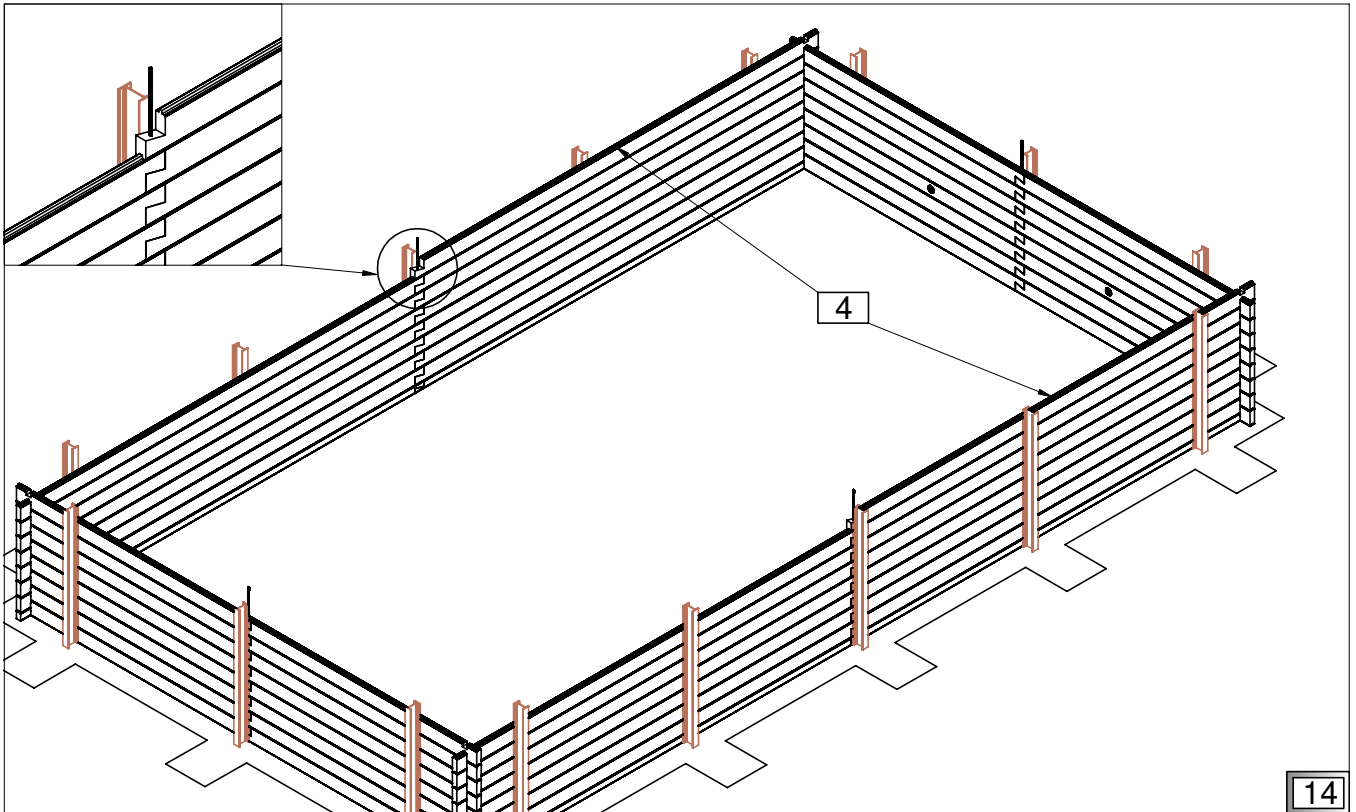

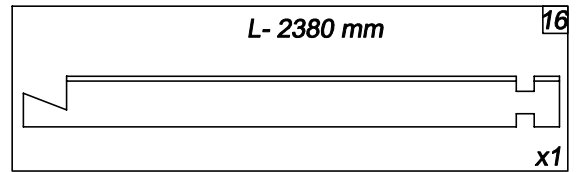
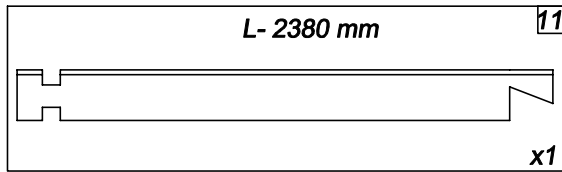

IX

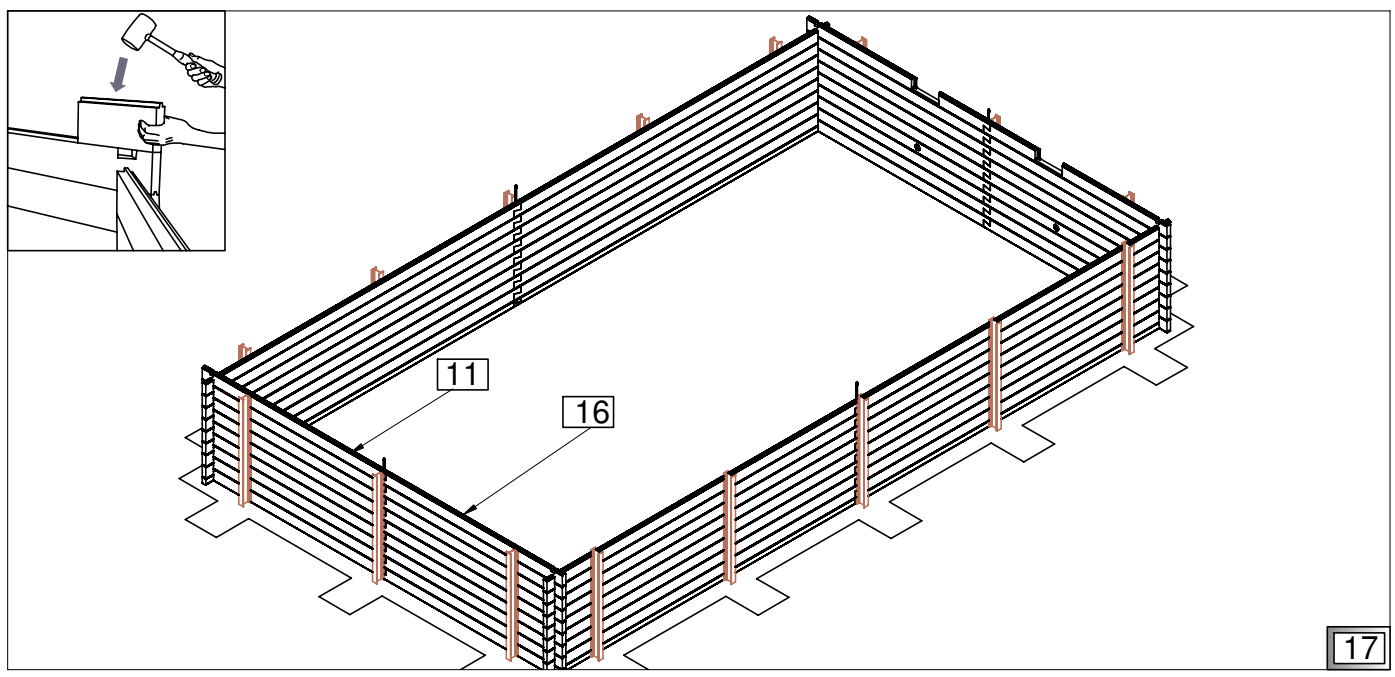
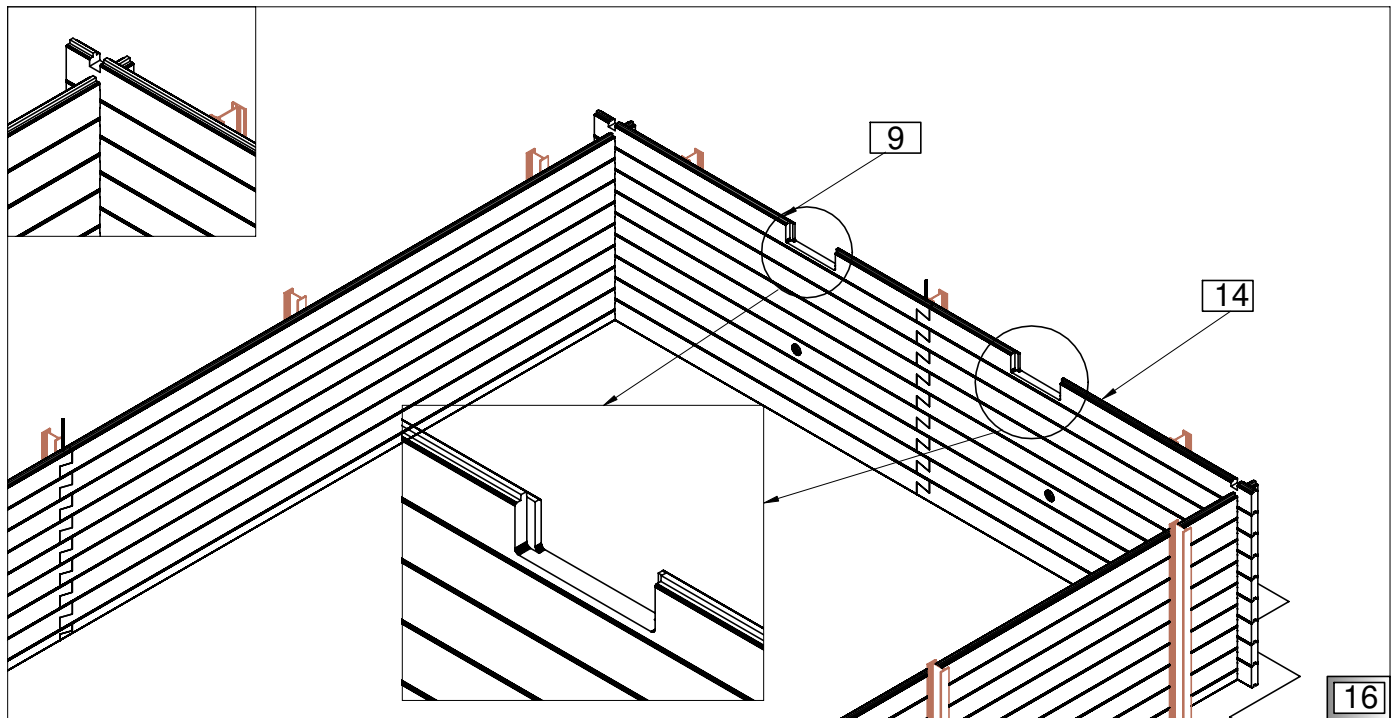
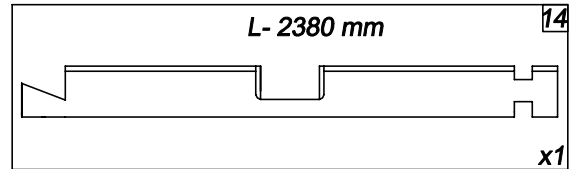
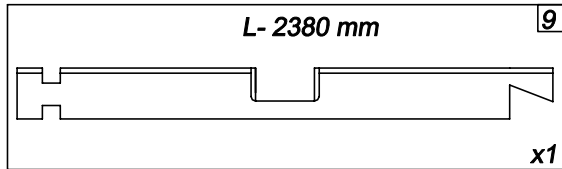

17

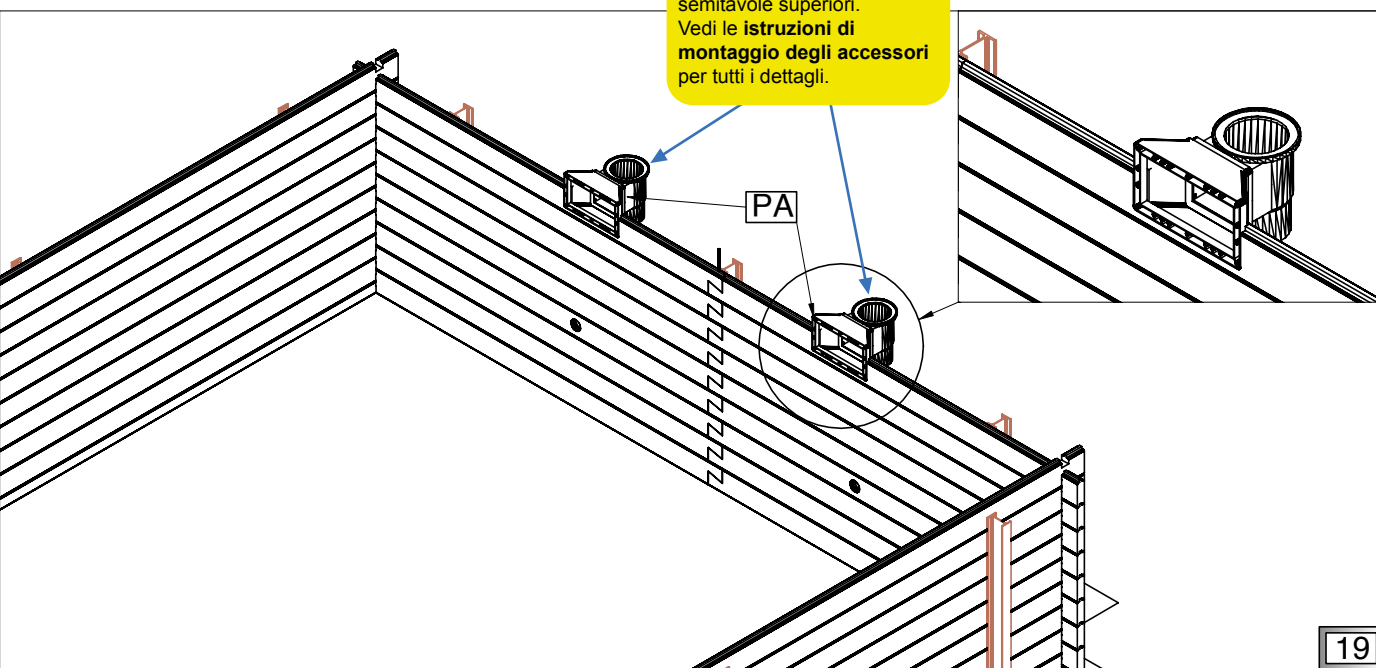
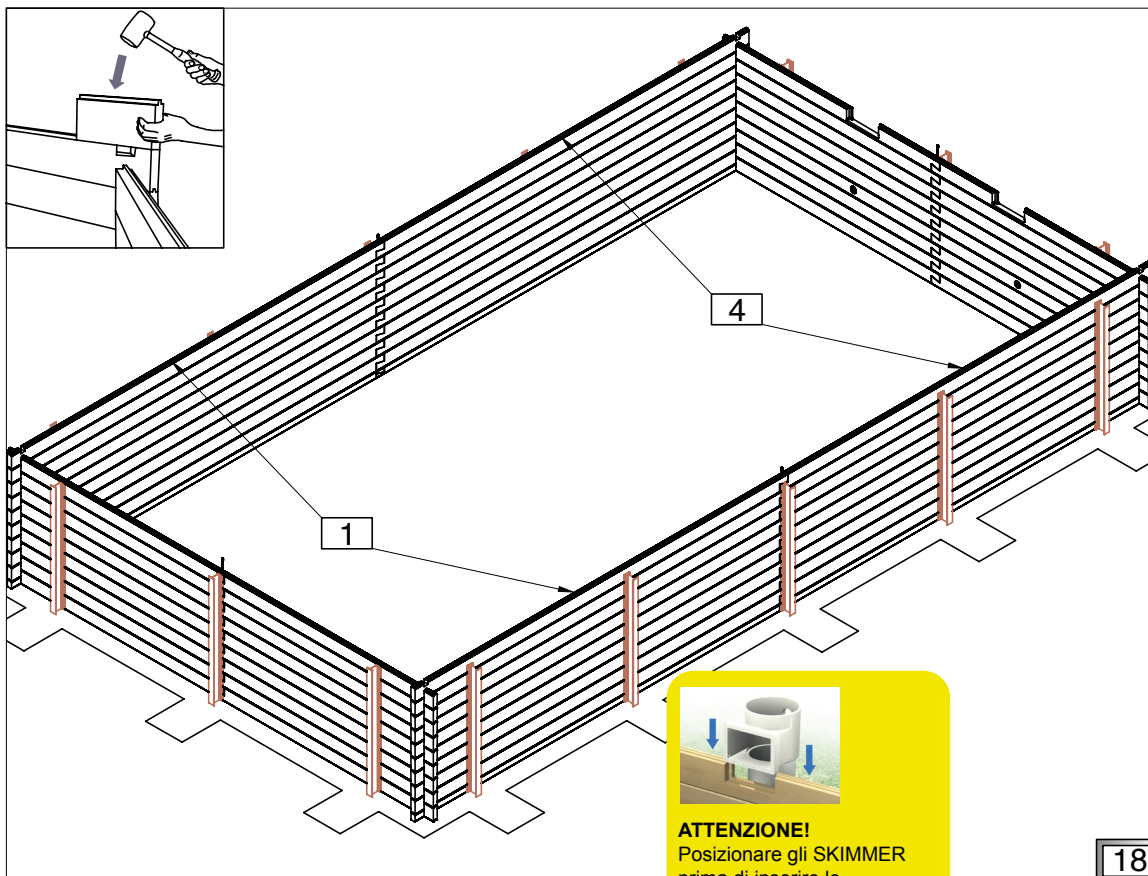
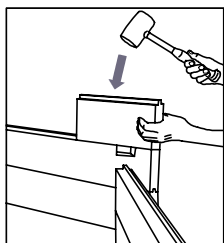
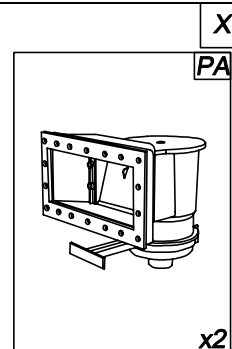
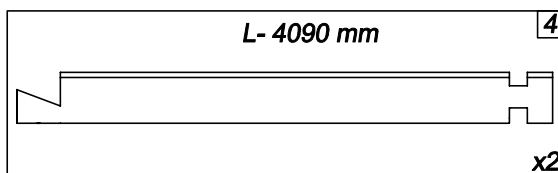
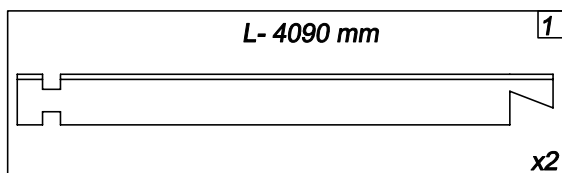
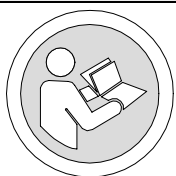

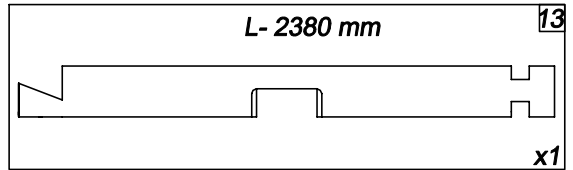
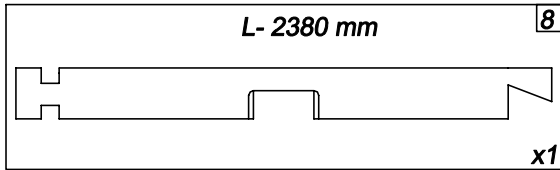

X

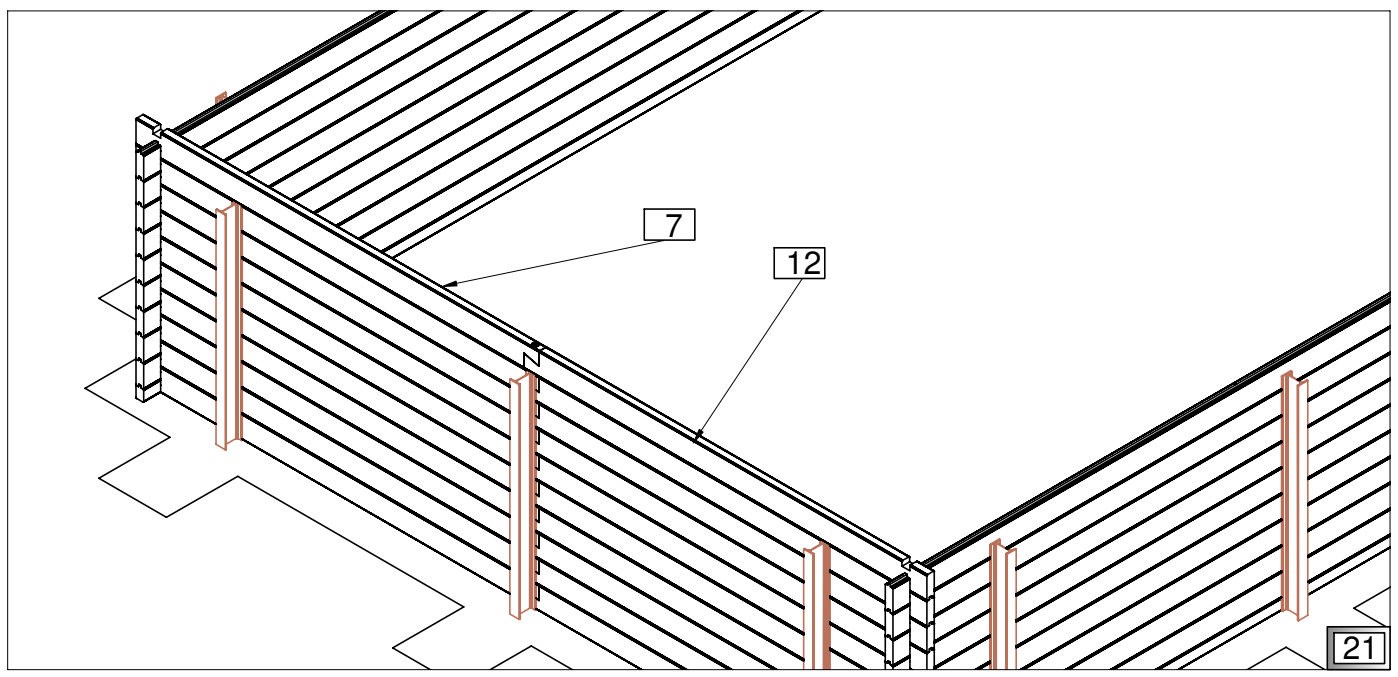
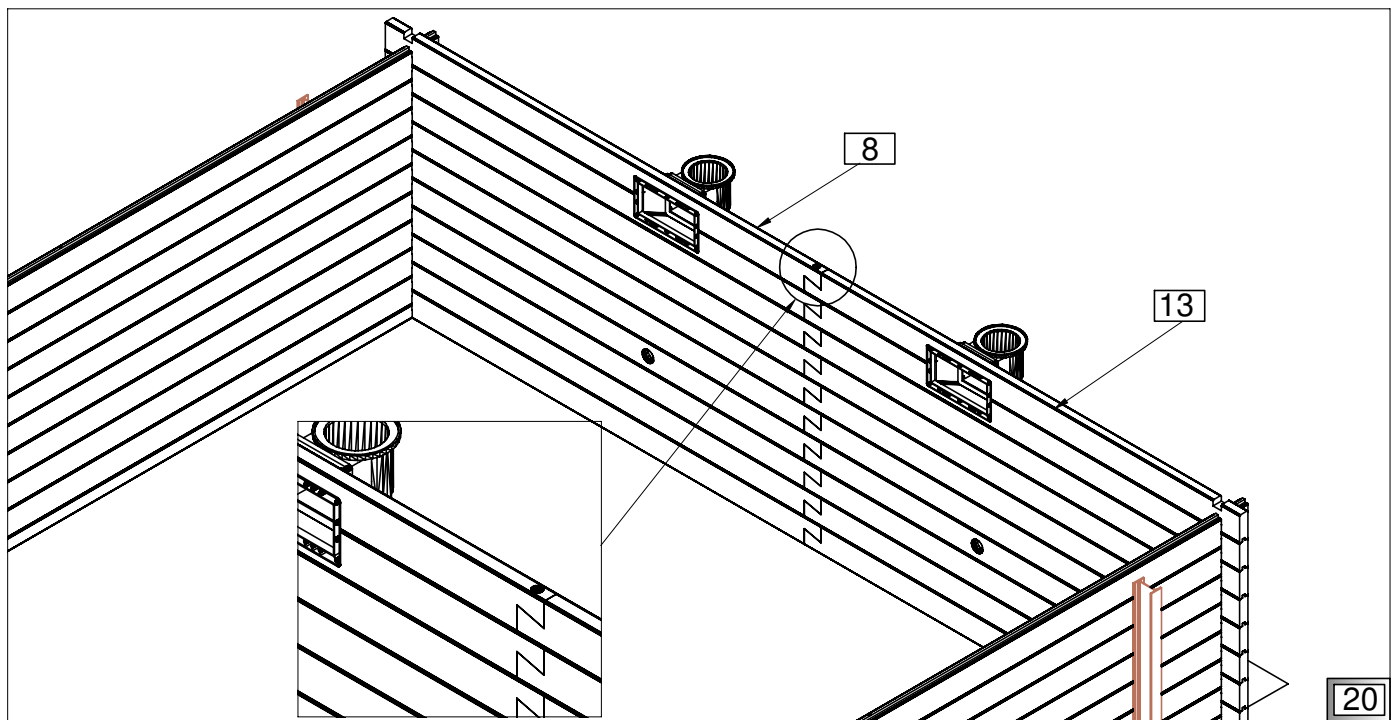
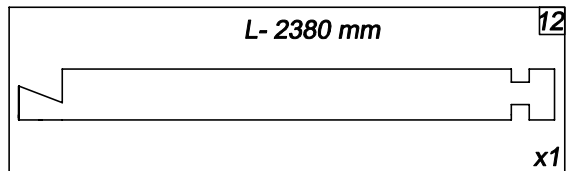
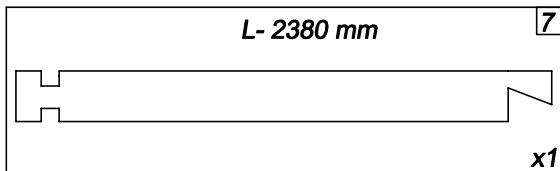

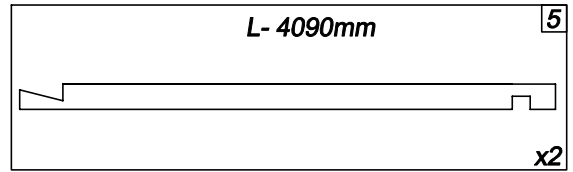
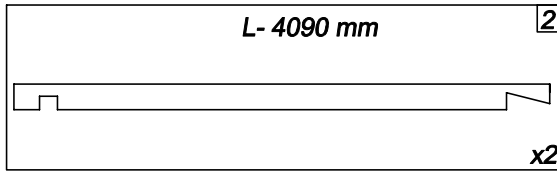

X

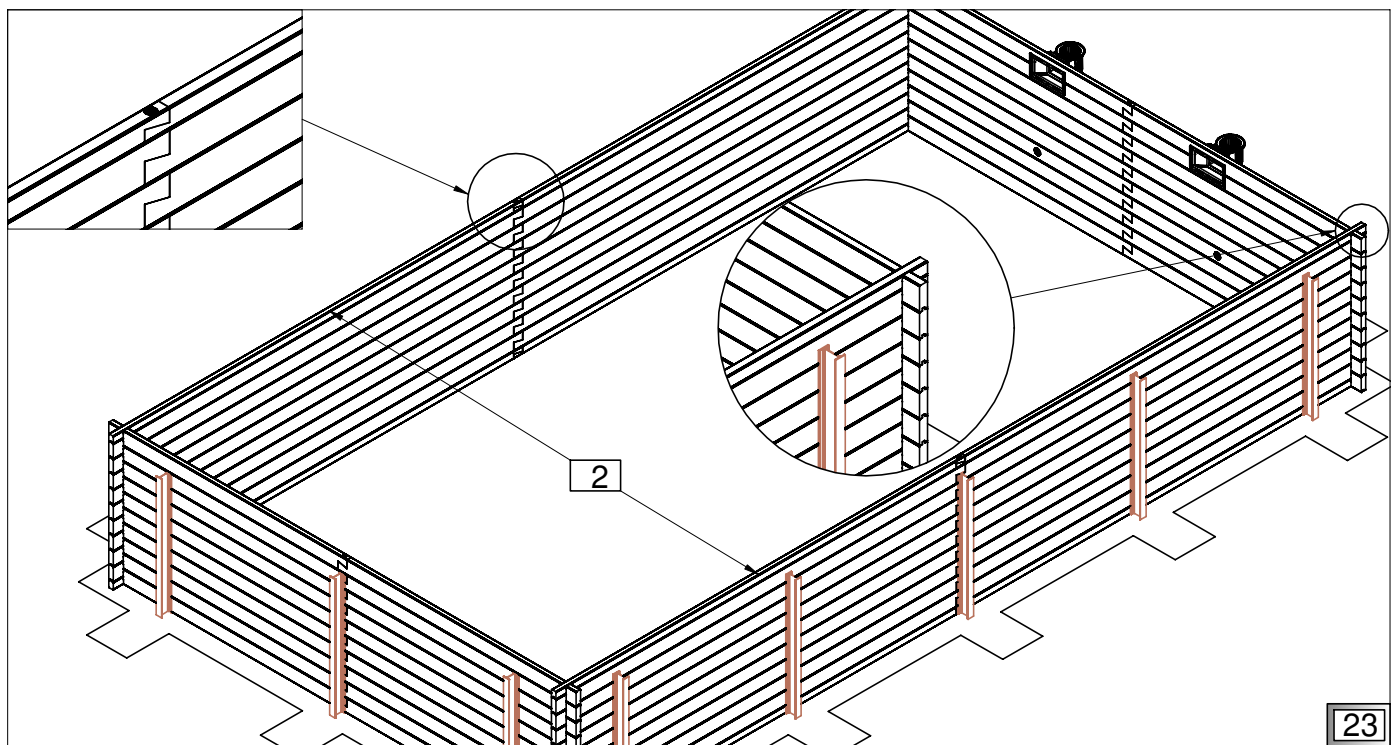
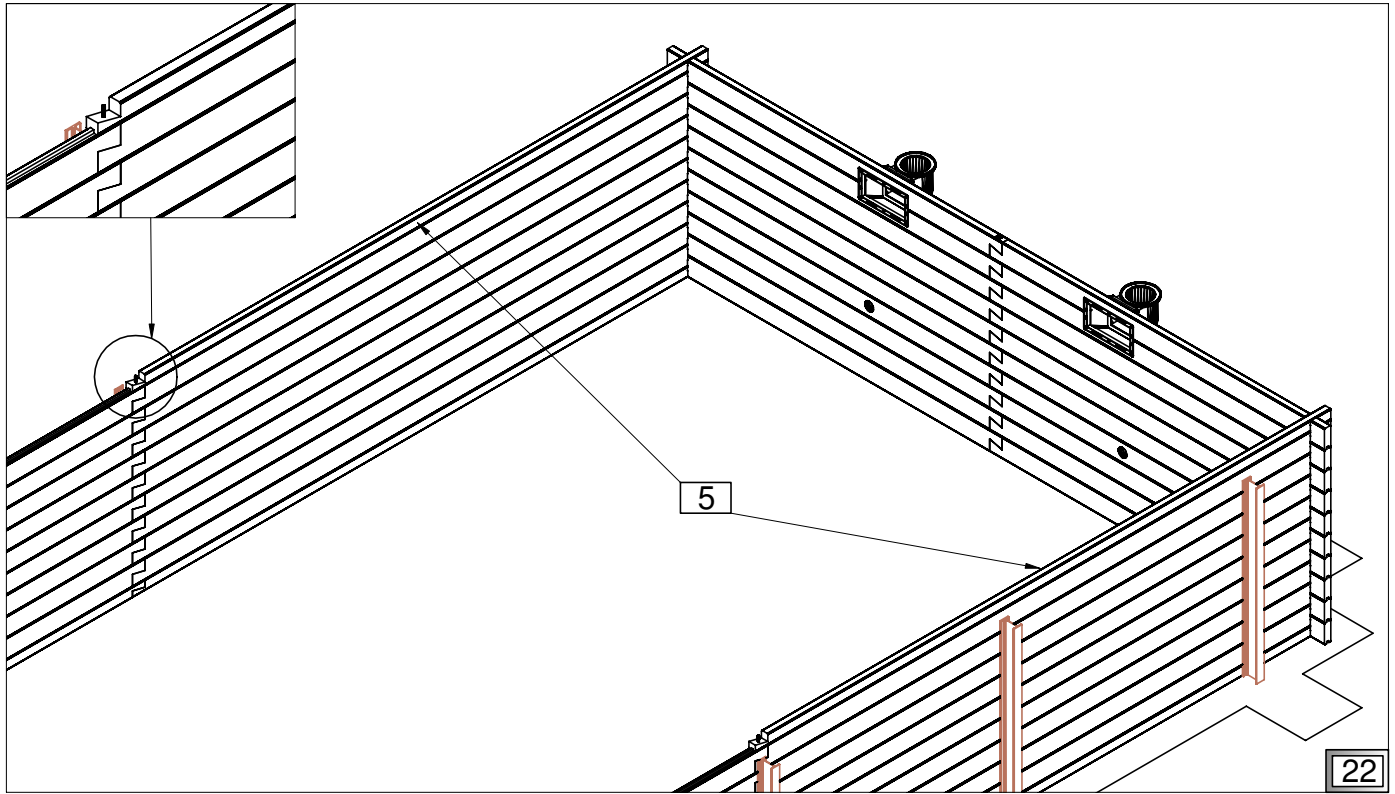

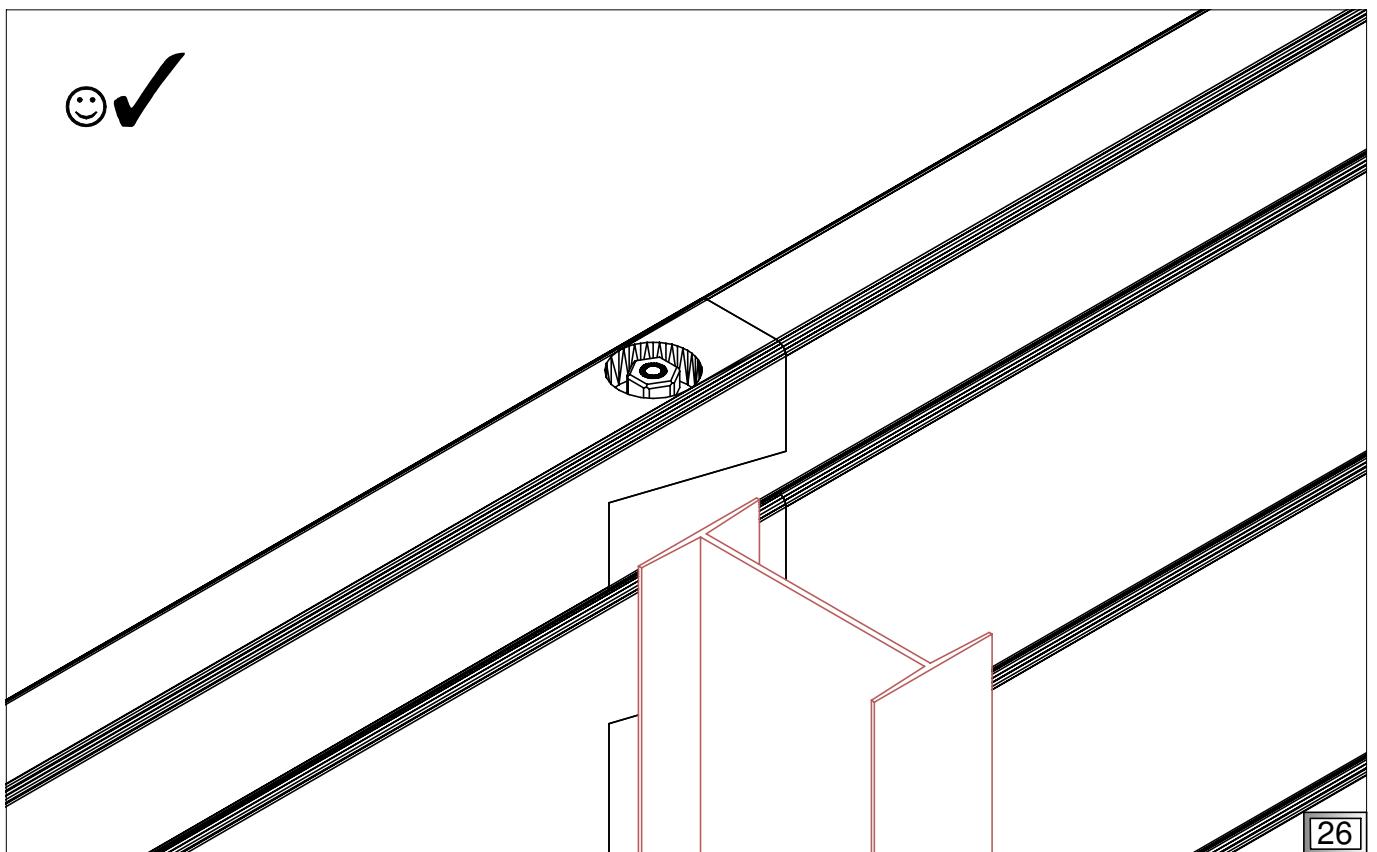
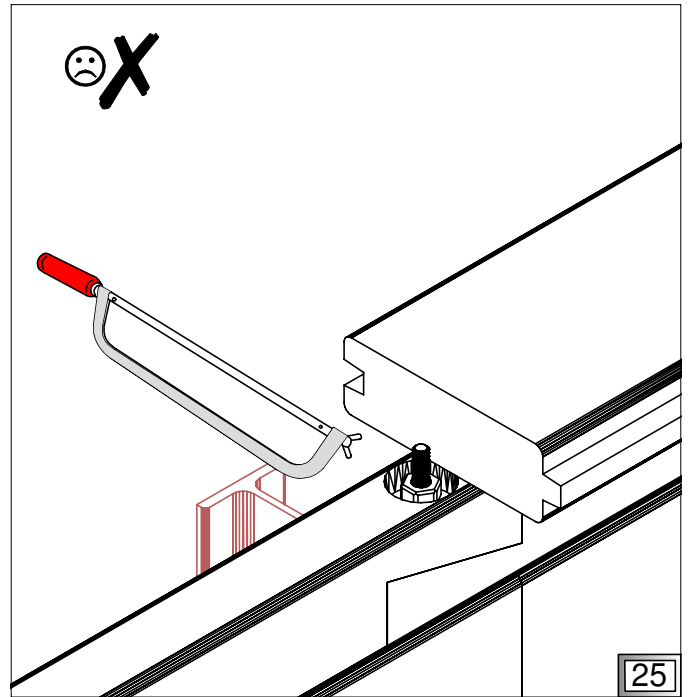
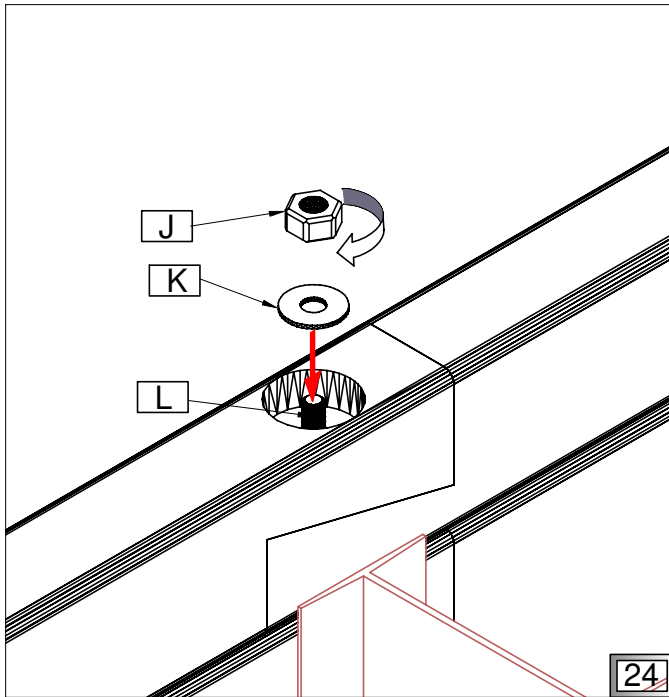
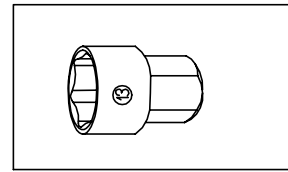
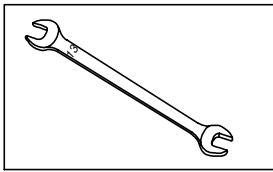
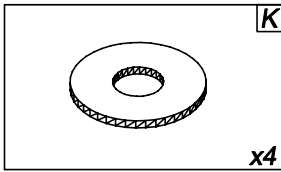
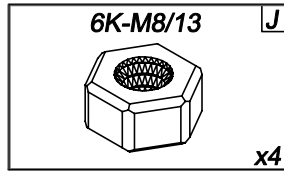

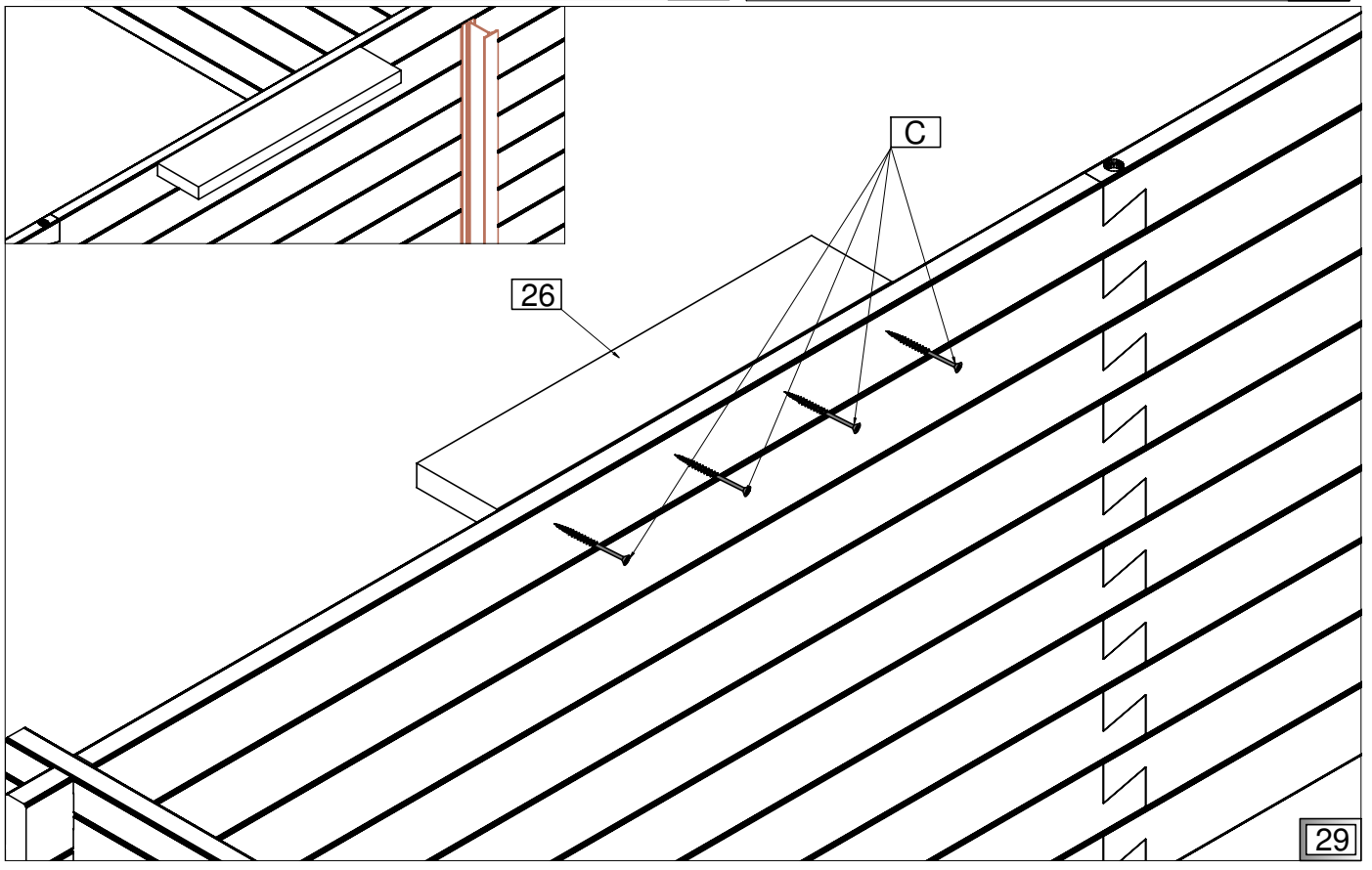
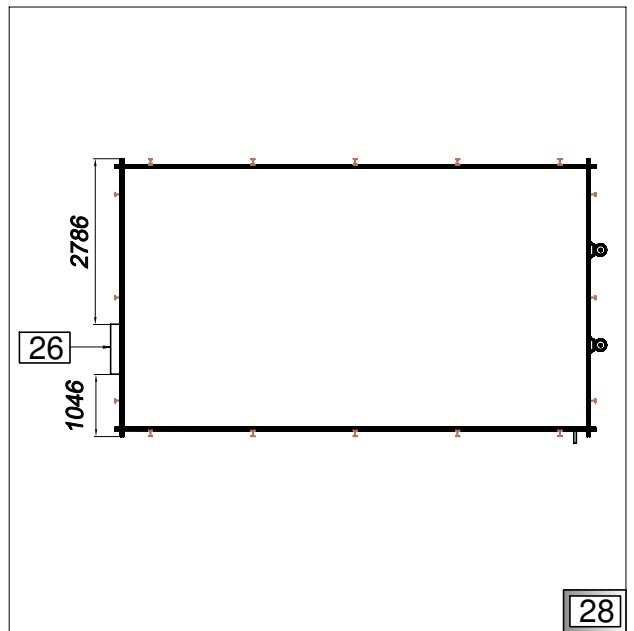
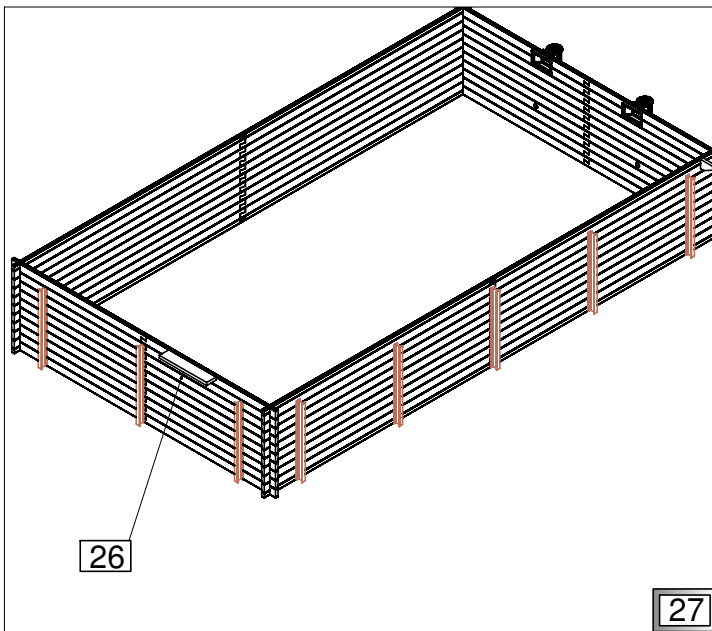
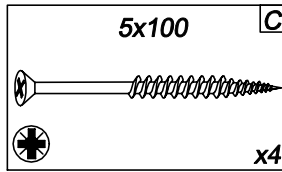
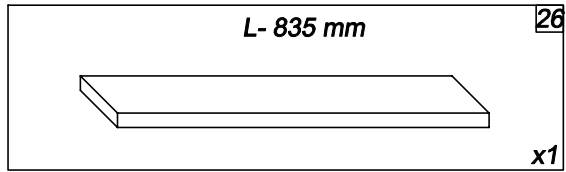

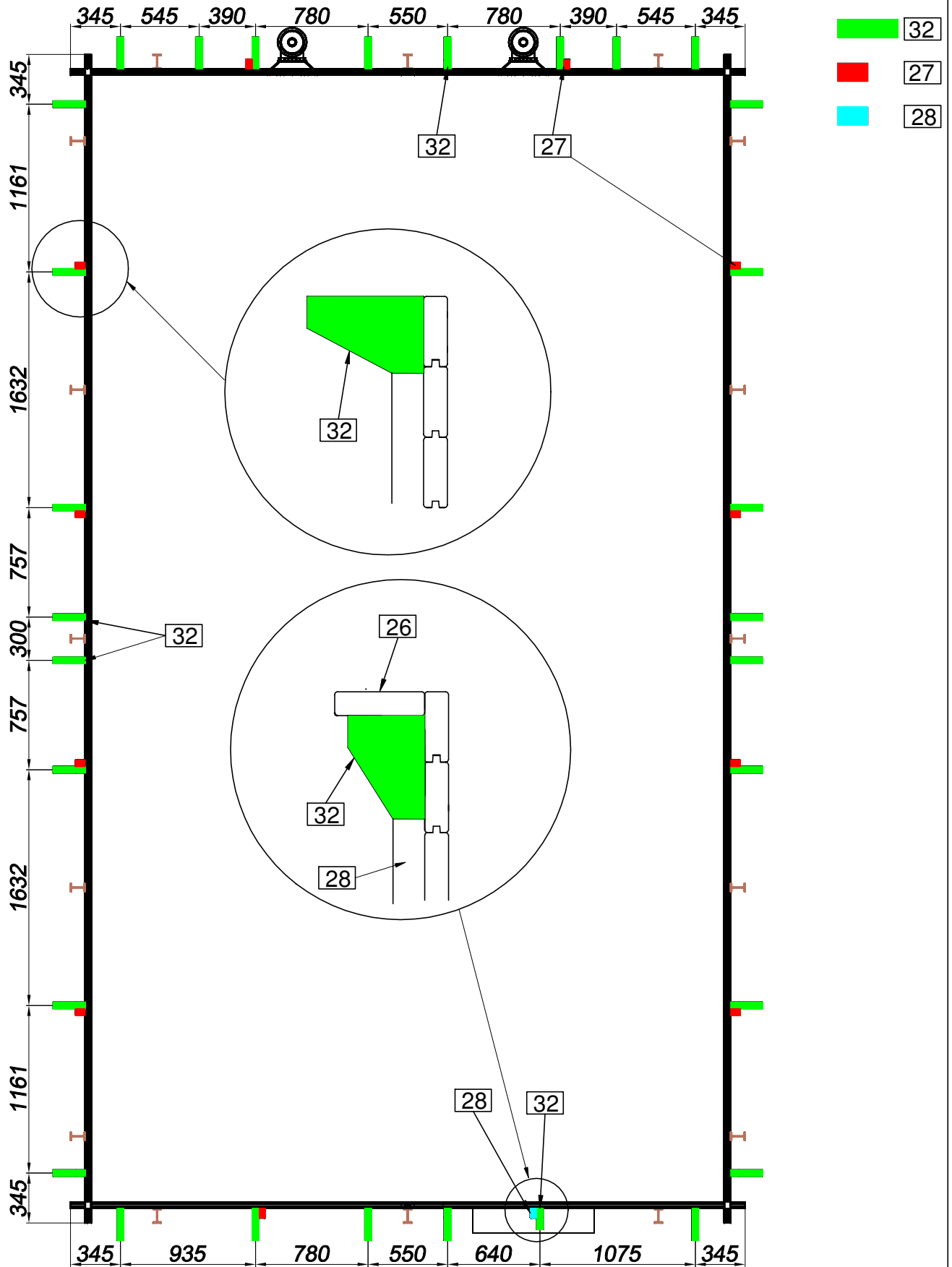

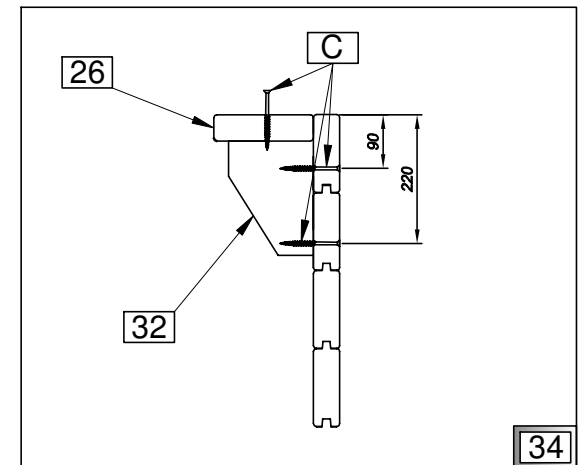
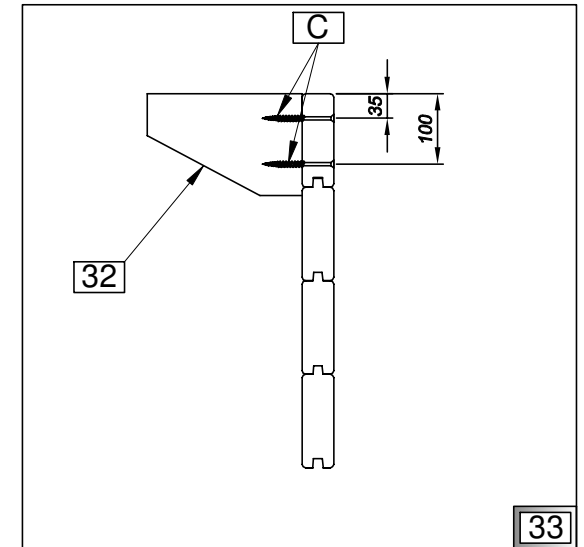
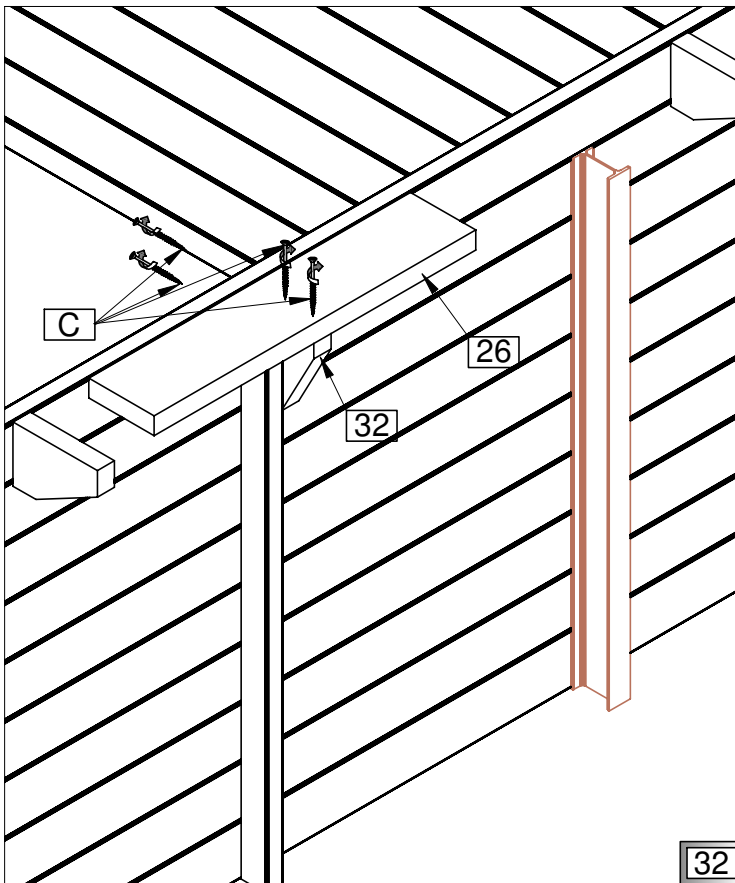
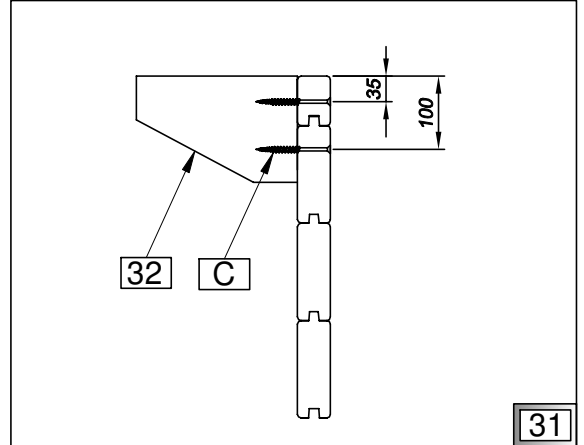
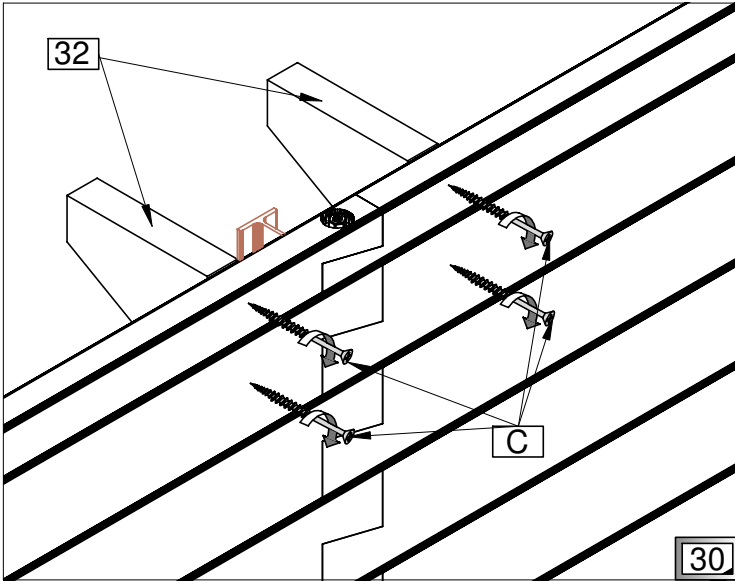
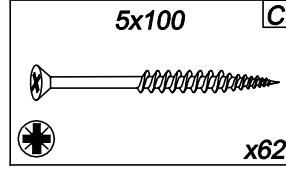
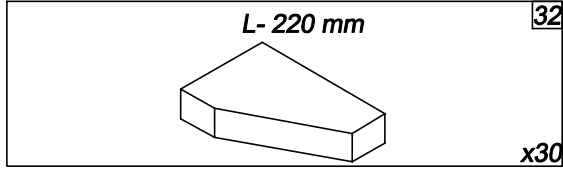

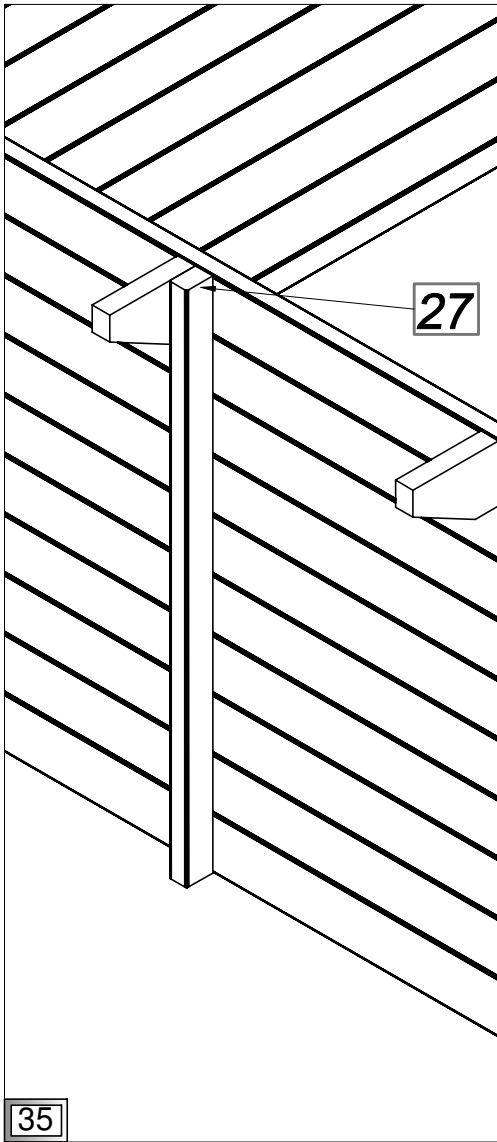
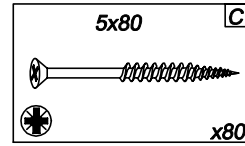
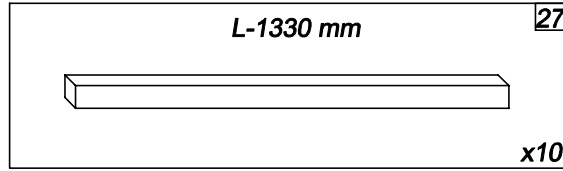

35

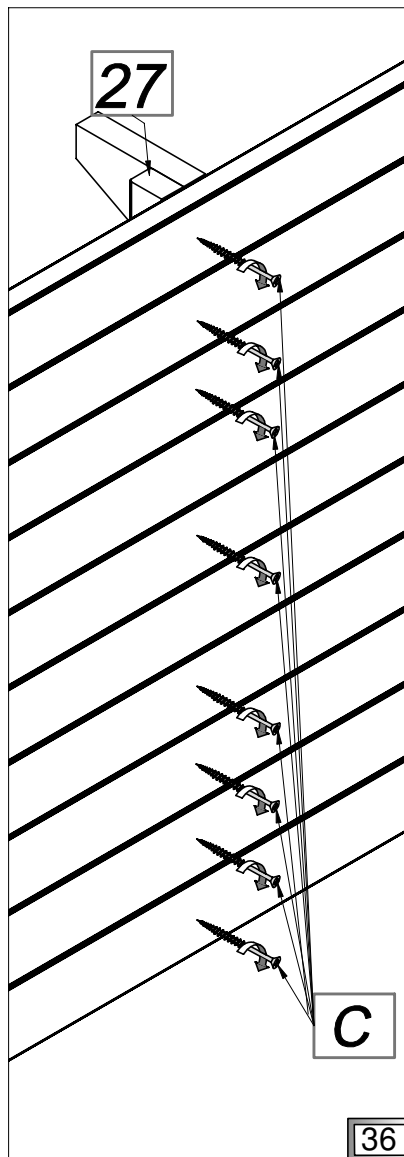

36

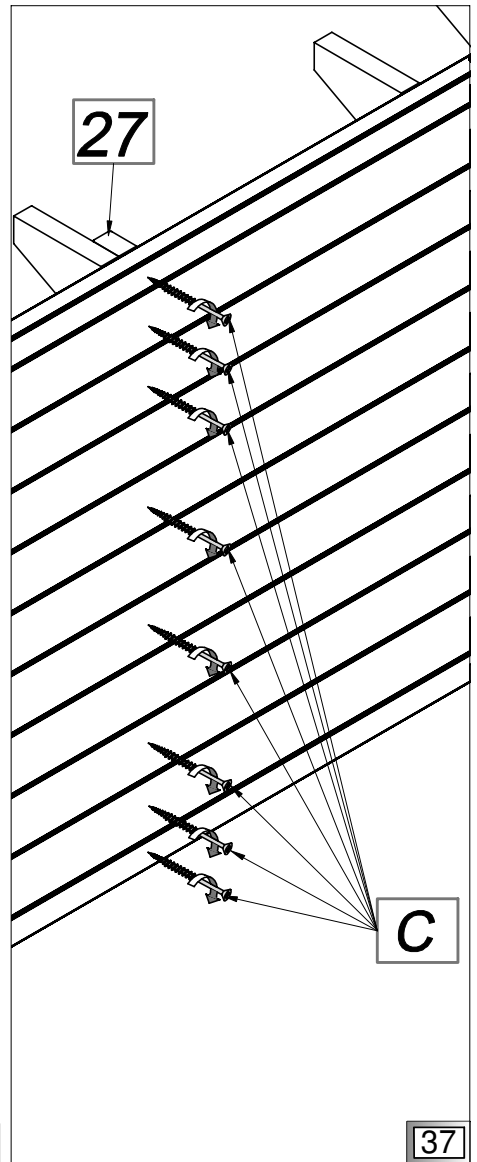

37

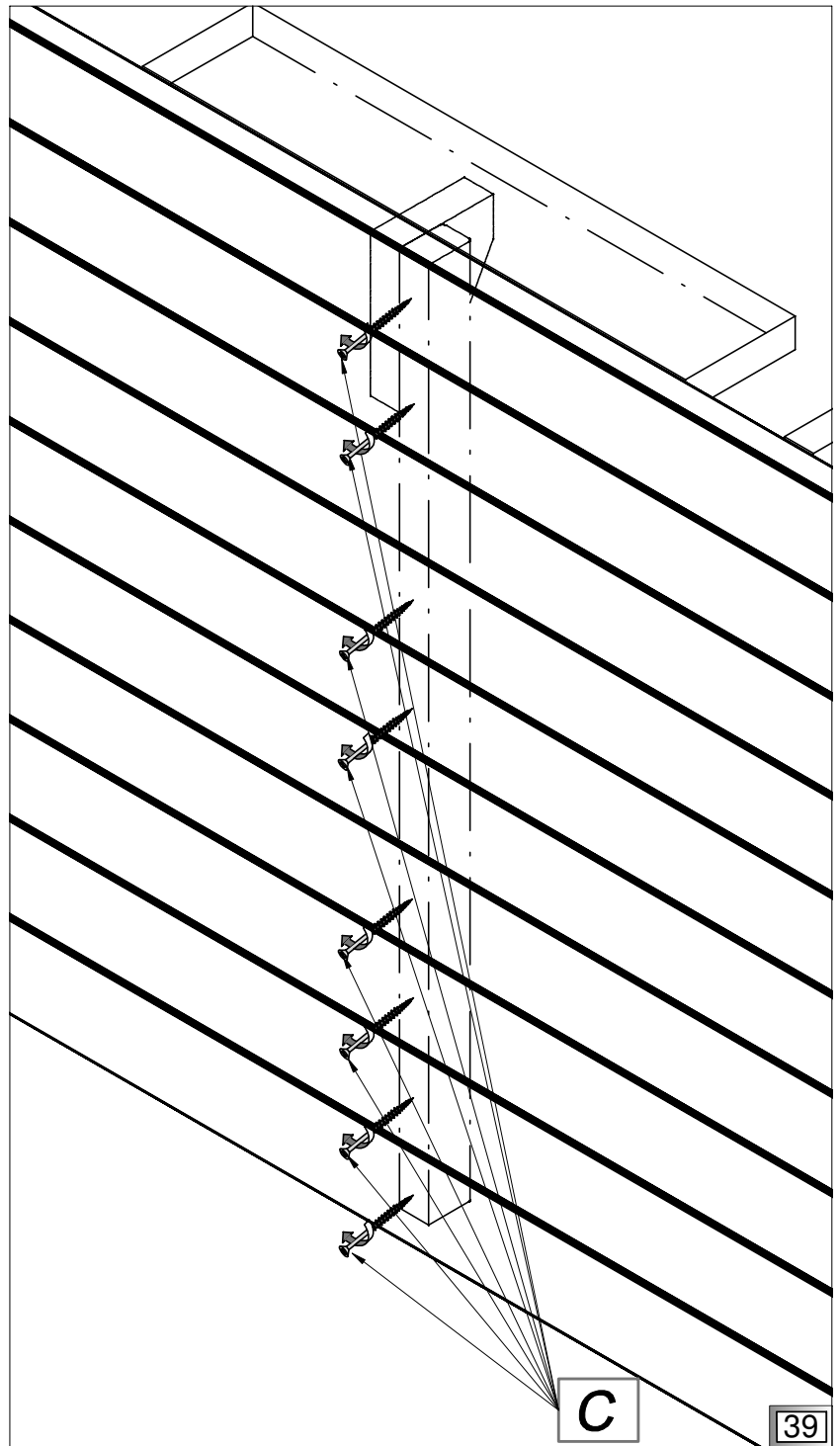
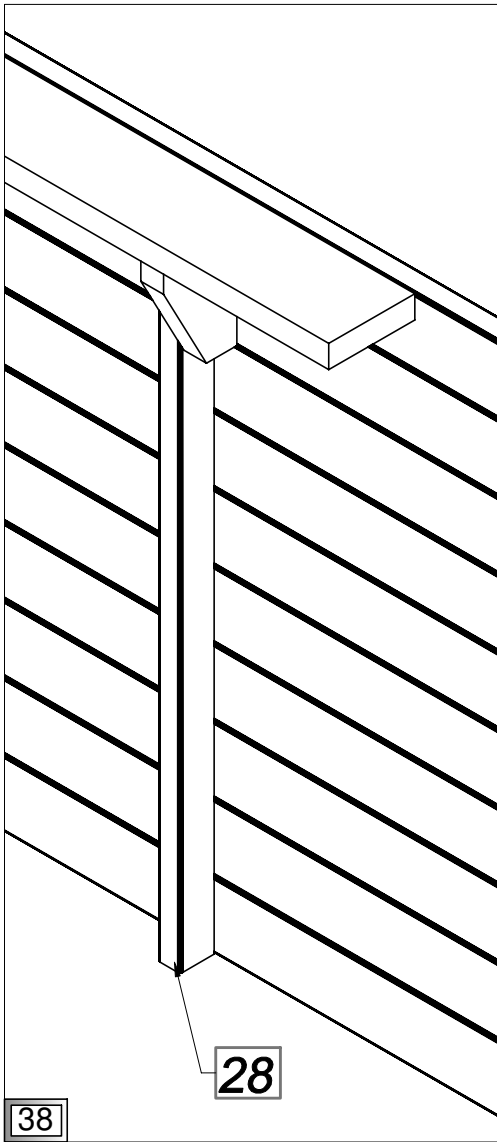
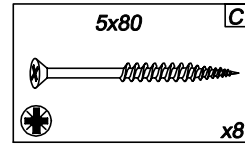
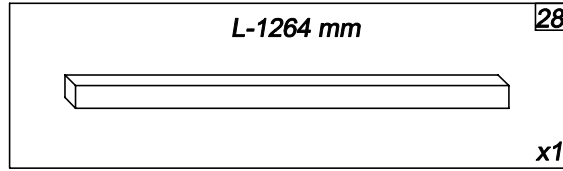

38

28

C

39

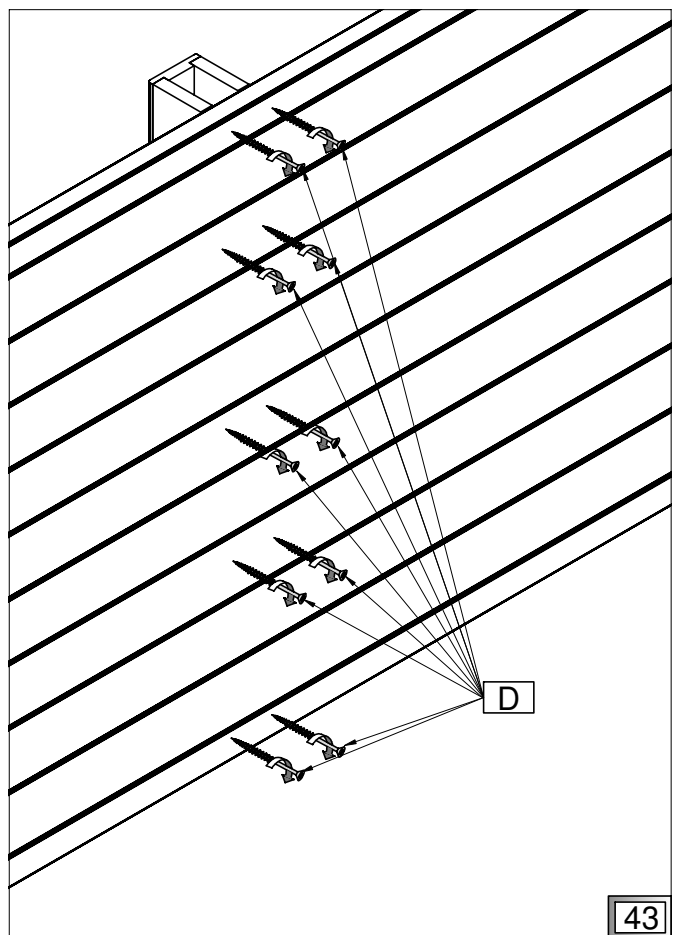
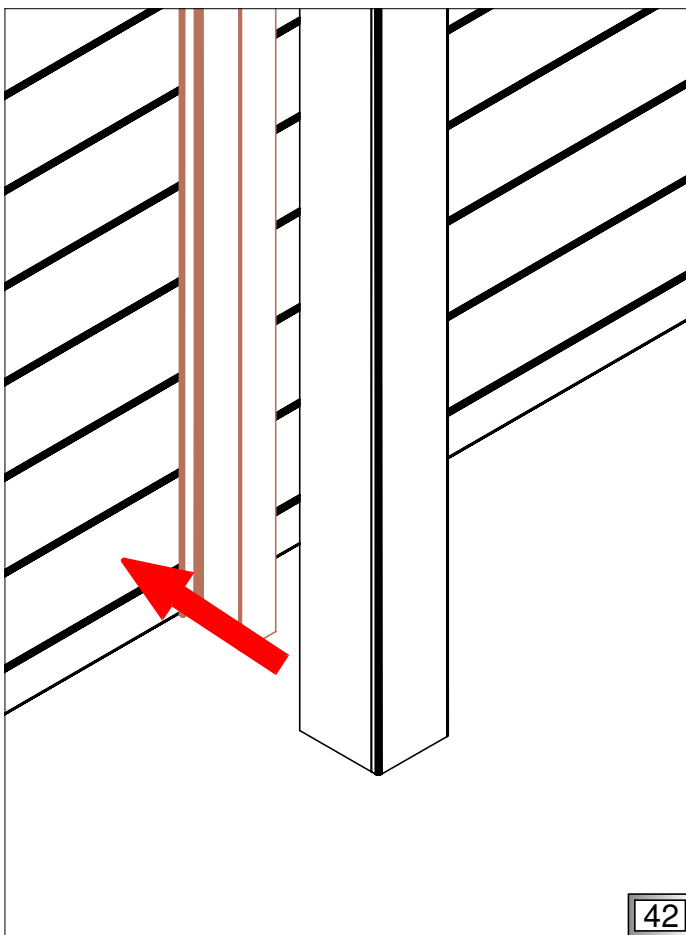
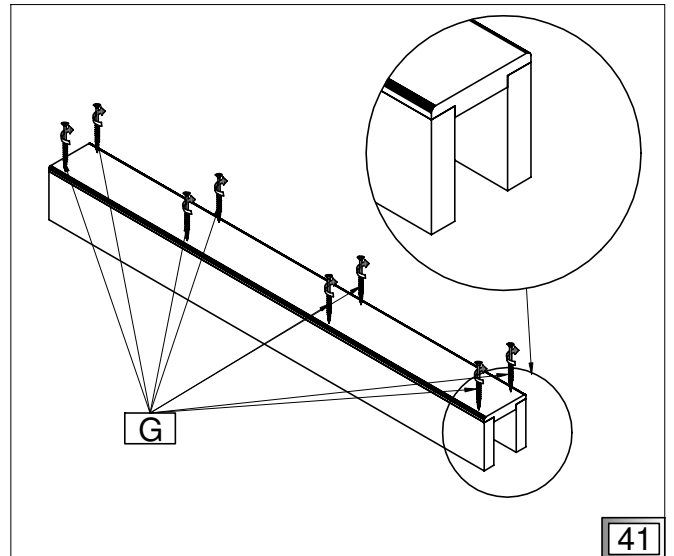
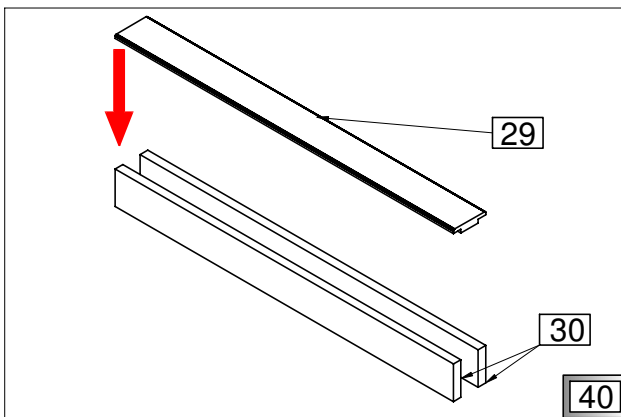
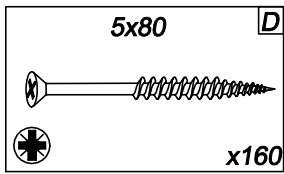
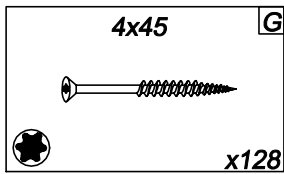
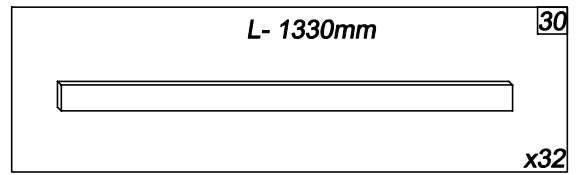
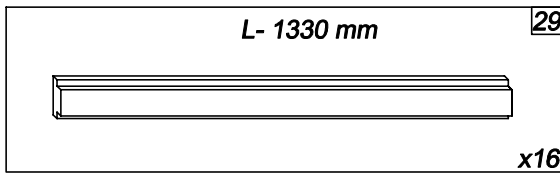

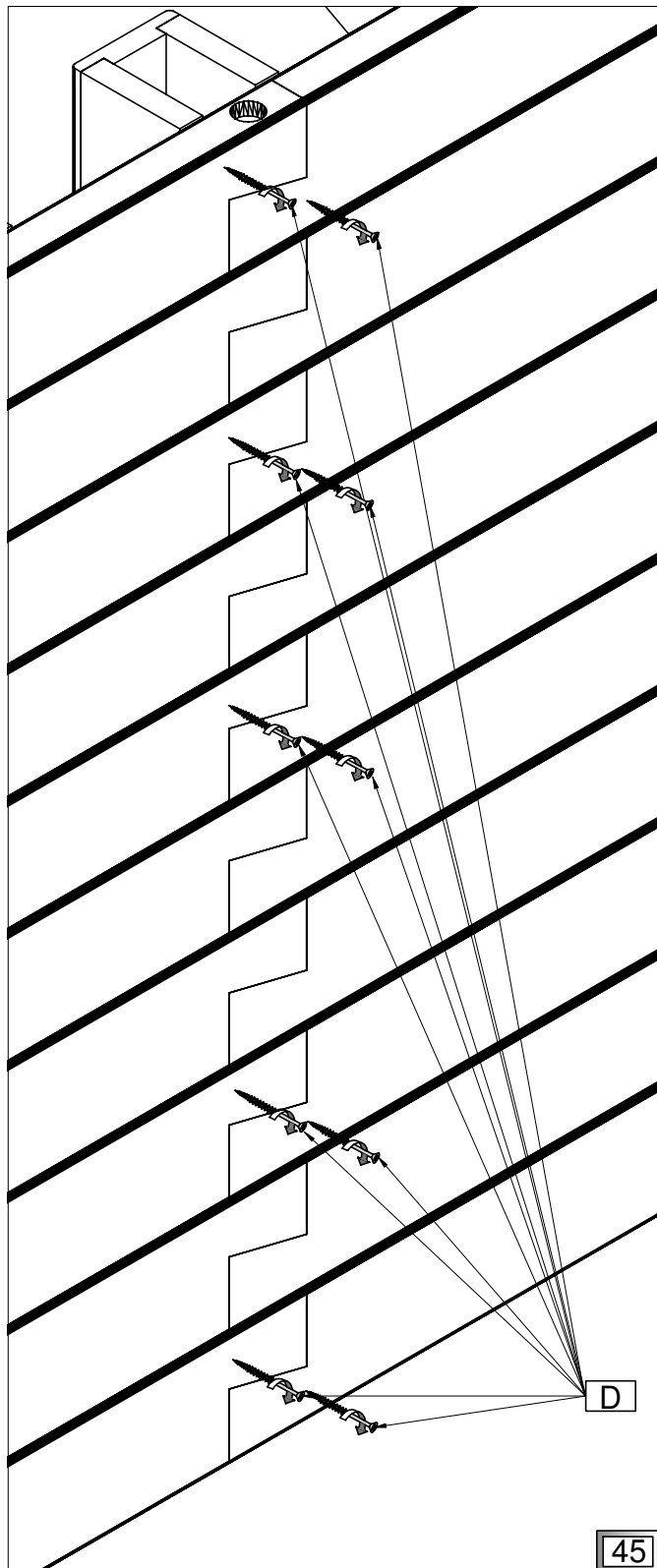
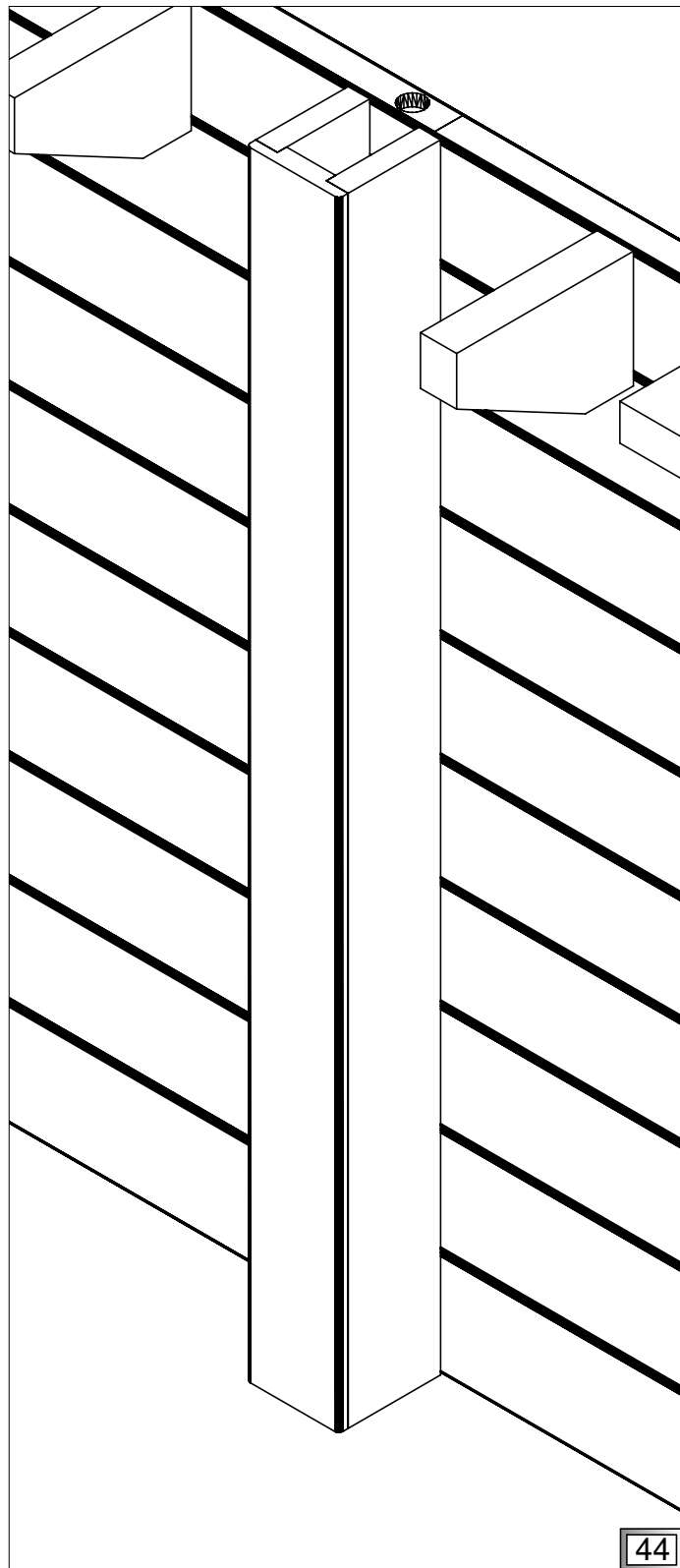

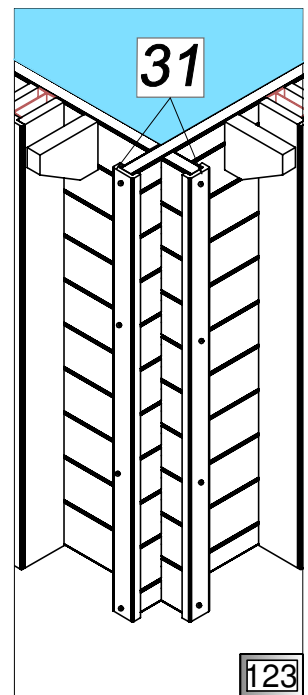
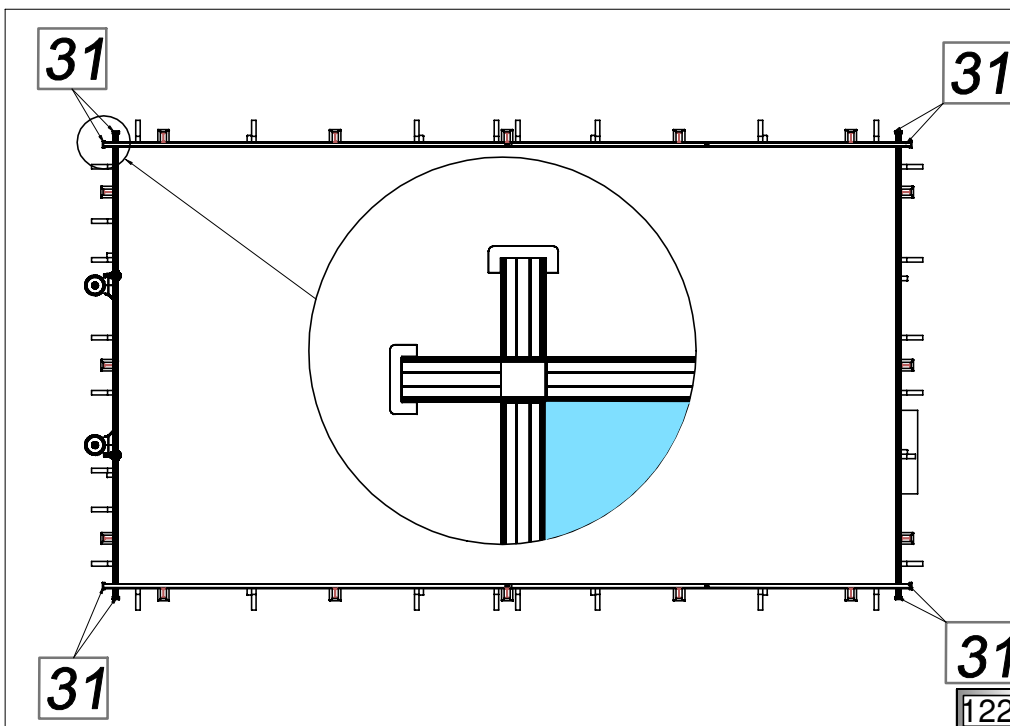
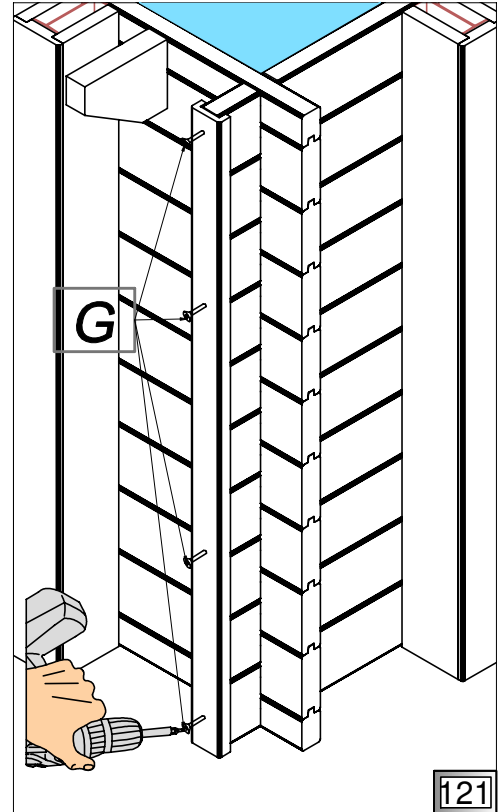
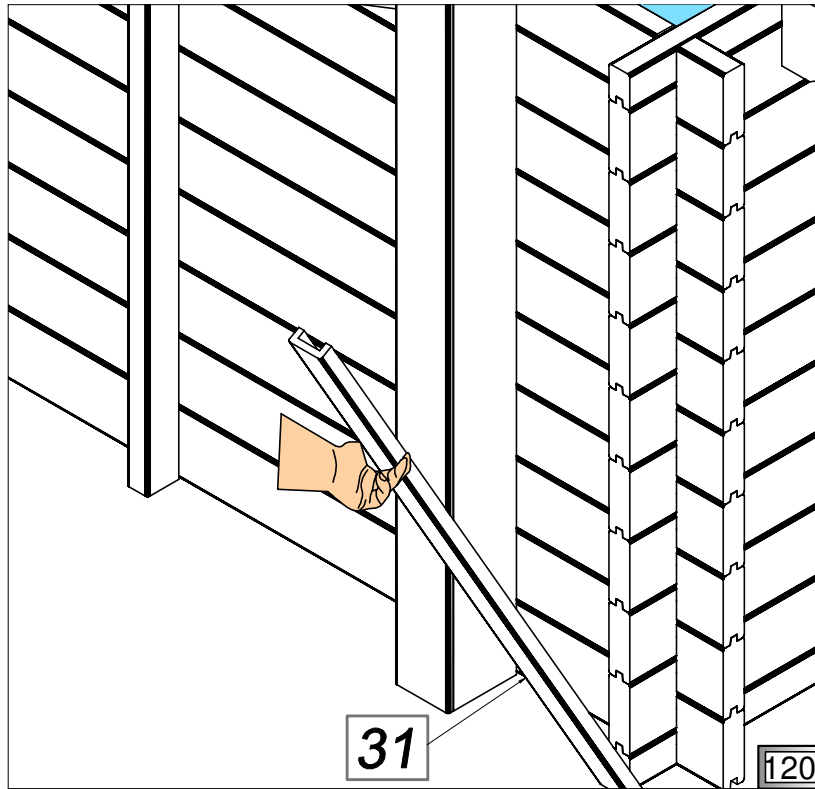
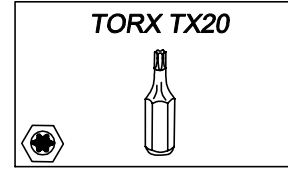
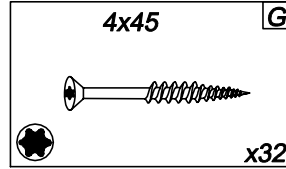
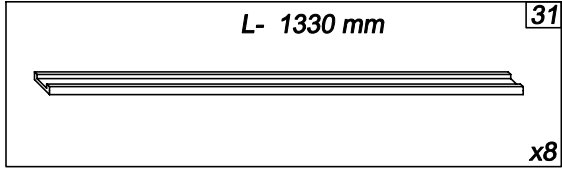

PL Taras

GB Terrace

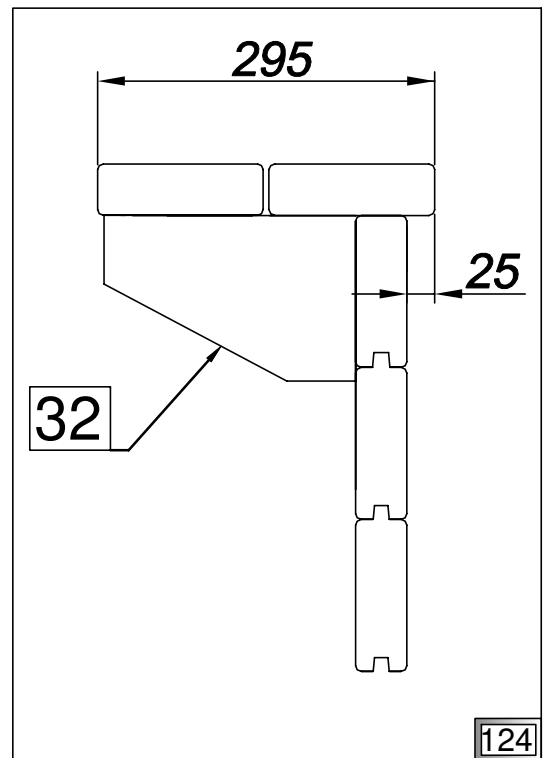
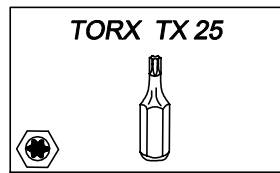
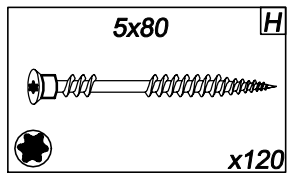
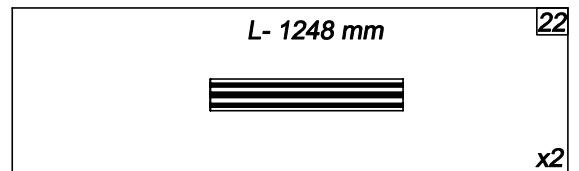
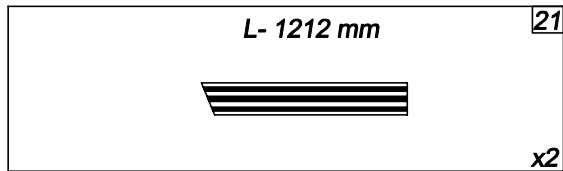
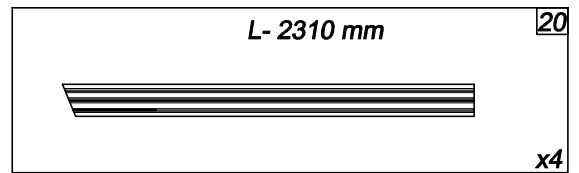
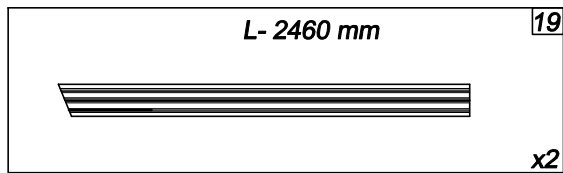
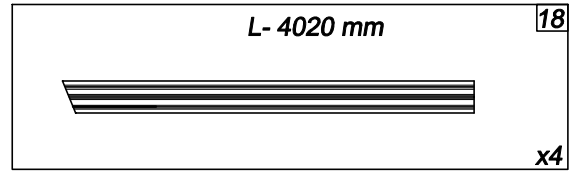
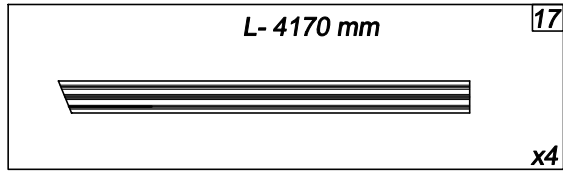

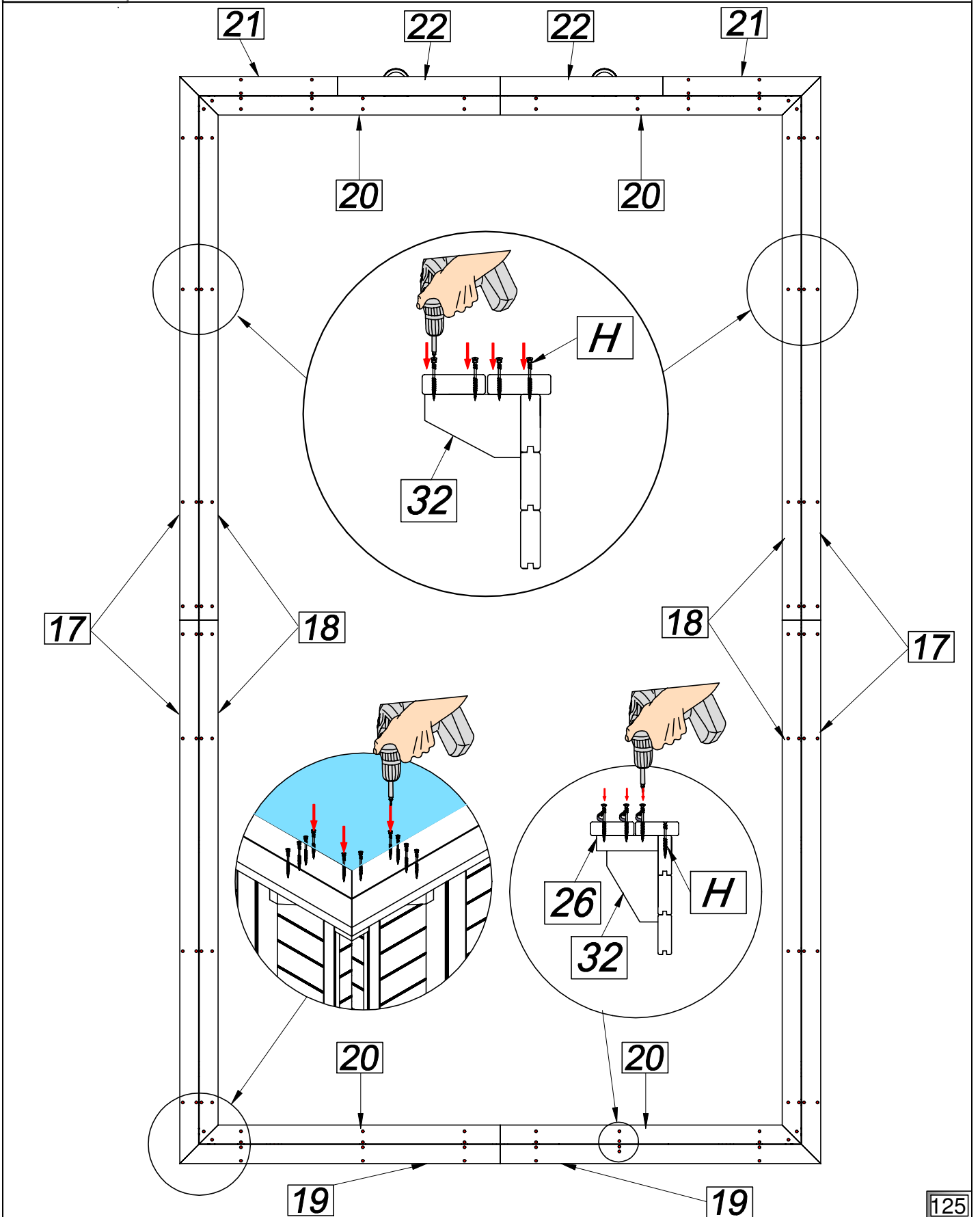

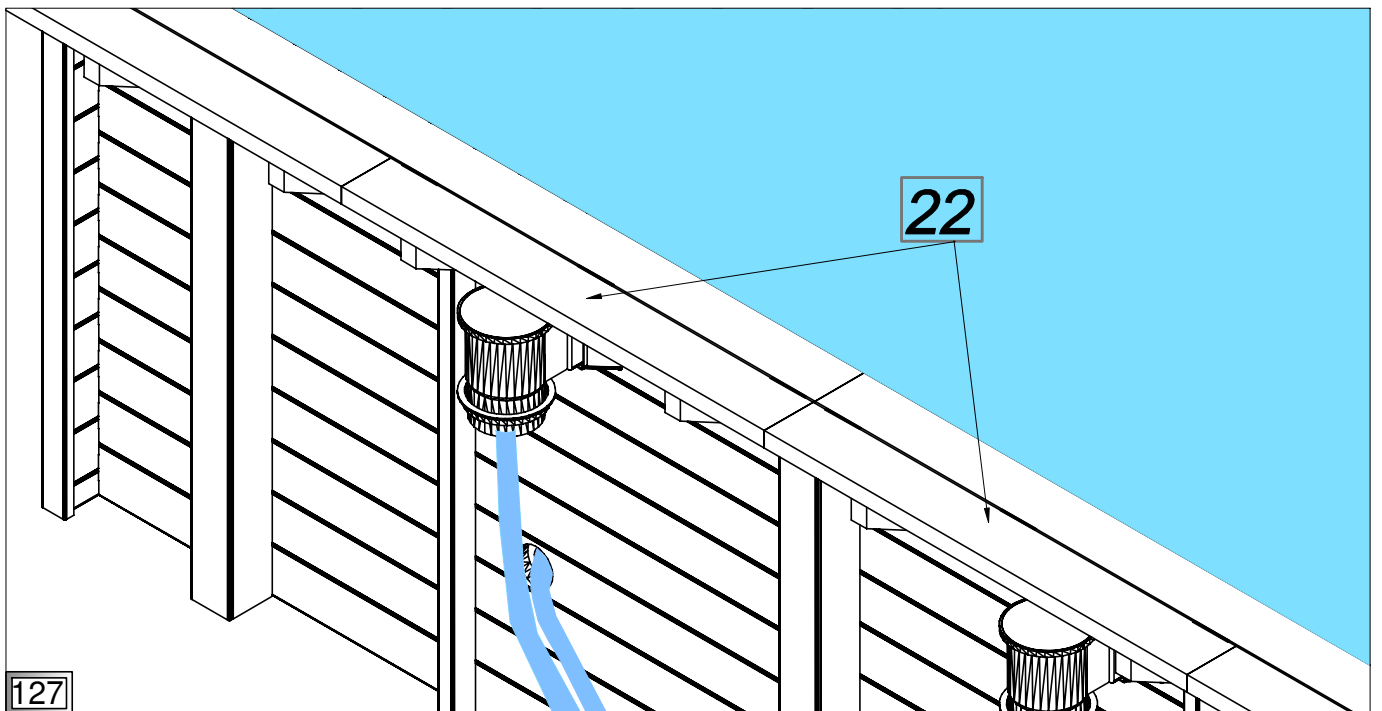
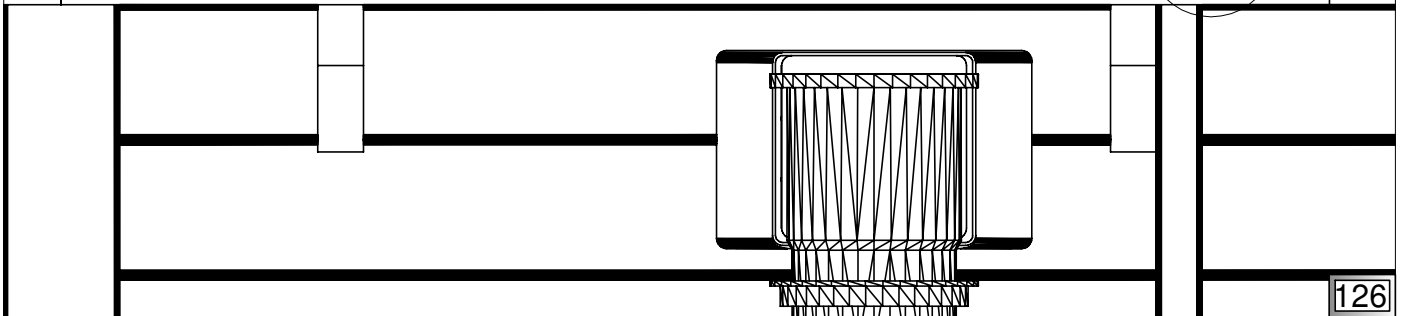
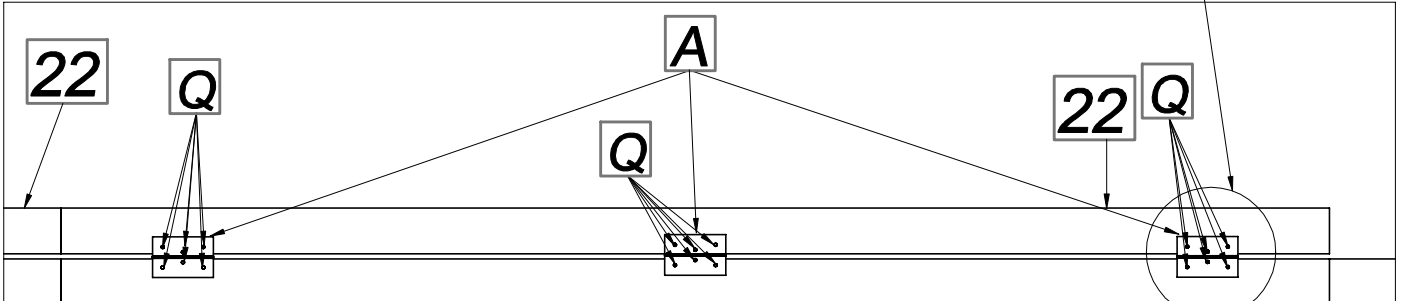
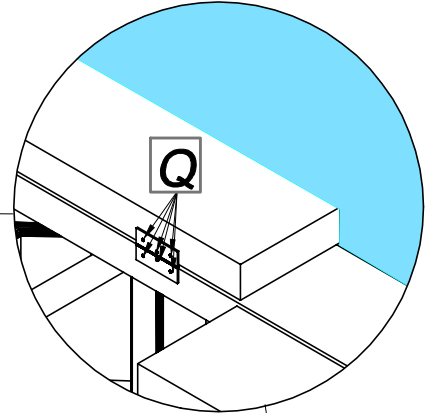
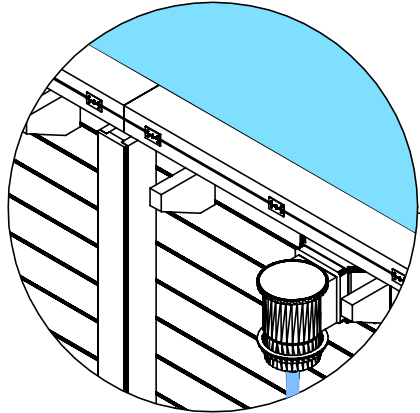
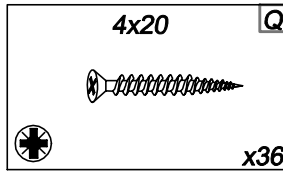
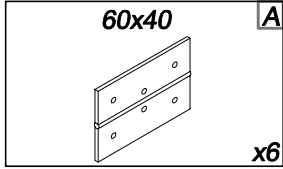

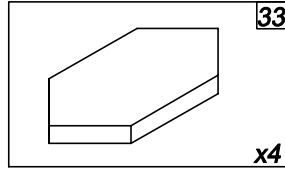
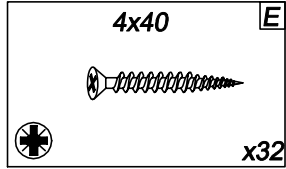

PL Widok od spodu tarasu.

GB View from the bottom of terrace.

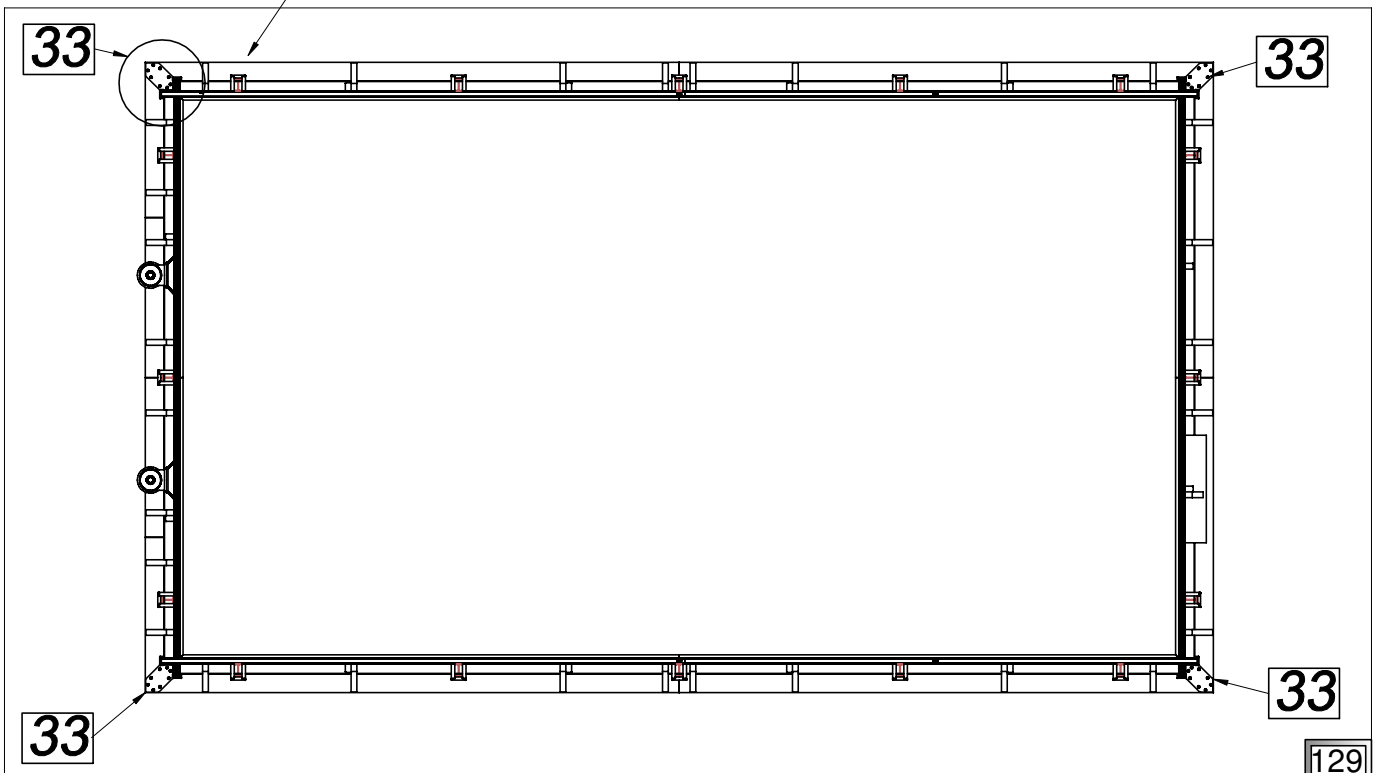
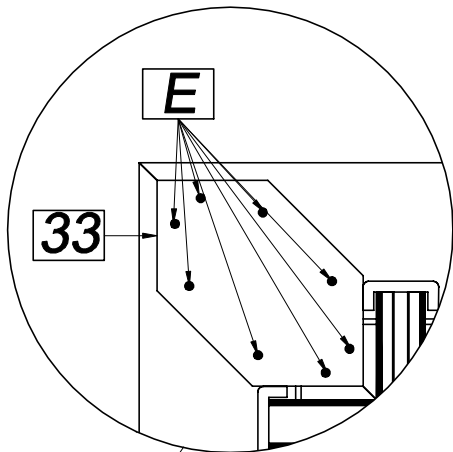
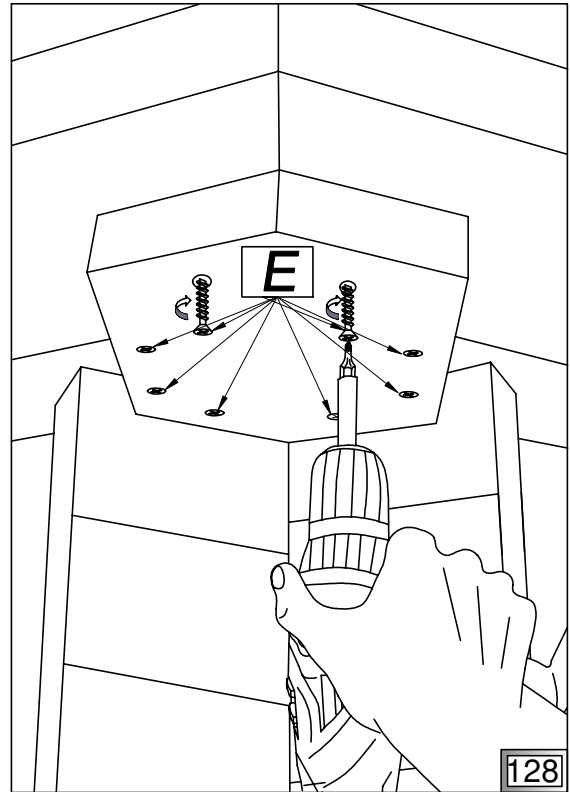

PL Schody drewniane

GB Wooden stairs

