

# ALICIA



 **Aufbauanleitung**

 **notice de montage**







 **Building Instructions**



 **montagehandleiding**







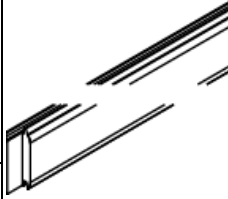
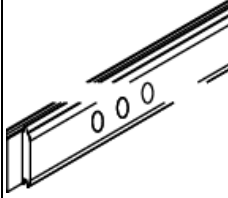
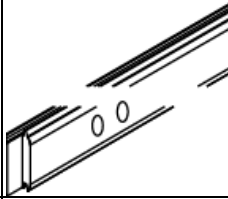



 **Instrucciones de  
construcción**







 **Istruzioni per il  
montaggio**



# 85825







					
<p>Vergleichen Sie zuerst die Materialliste mit Ihrem Paketinhalt! Bitte haben Sie Verständnis, dass Beanstandungen nur im <u>nicht aufgebauten</u> Zustand bearbeitet werden können!</p>	<p>Vergelijk eerst de lijst van materialen met de inhoud van uw pakket! Reclamaties kunnen alleen in behandeling worden genomen zolang de onderdelen <u>nog niet zijn gemonteerd!</u></p>	<p>Veillez d'abord comparer la liste du matériel avec le contenu de votre colis! Nous vous remercions de bien vouloir comprendre que les réclamations ne peuvent être traitées qu'à l'état <u>non monté!</u></p>	<p>En primer lugar, compare la lista de material con el contenido del paquete. Rogamos entienda que las reclamaciones sólo pueden ser tramitadas <u>antes montar el objeto.</u></p>	<p>Firstly compare the material list with the contents of your package! Please appreciate that complaints can be processed only in the <u>non-assembled state!</u></p>	<p>Confrontare la distinta dei materiali con il contenuto del pacchetto! Le reclamazioni potranno essere accettate solamente se i prodotti <u>non sono ancora stati montati!</u></p>

Art.Nr. Art.-nr. Art. N° N° Art. Art. no. Art.N°:	Nr Nr. N° N° No. N°:	Bezeichnung Benaming Désignation Denominación Description Descrizione	Bild Afbeelding Illustration Dibujo Illustration Immagine	Länge Lengte Longueur r Long. Length Lungh.	Breite Breedte Largeur Ancho Width Largh.	Stärke Dikte Épaisseur Espesor Thick- ness Spess.	Material Materiaal Matériau Material Material Materiale	Stück Aantal Pièce Ctdad. Number Q.tà
26573	A	Wandbohle Rückwand Wandplank achterwand Madrier mural mur arrière Tablón pared posterior Wall board rear wall Asse parete posteriore		1380	121	38	Bohle Plank Madrier Tablón Board Asse	17
26573	B	Wandbohle Seite Wandplank zijkant Madrier mural côté Tablón pared lateral Wall board side Asse parete laterale		1380	121	38	Bohle Plank Madrier Tablón Board Asse	18
26726	C	Wandbohle Front Wandplank front Madrier mural façade Tablón pared delantera Wall board front Asse della parete frontale		777	121	38	Bohle Plank Madrier Tablón Board Asse	17
26579	D	Wandbohle Front Zuluft Wandplank front luchttoevoer Madrier mural façade, aération Tablón pared delantera entrada de aire Wall board front air inlet Asse parete anteriore con areazione			777	121	38	Bohle Plank Madrier Tablón Board Asse
21867	G	Wandbohle Abluft Wandplank luchtafvoer Madrier mural, évacuation de l'air Tablón pared salida de aire Wall board exhaust air Asse parete aerazione		1380	121	38	Bohle Plank Madrier  Tablón Board Asse	1
21431	H	Aufrechte Rahmen Hoekstijlen Cadres verticaux Marco vertical Upright frame Cornice verticale		1916	36	36	Rahmen Raamwerk Cadre Marco Frame Telaio	3





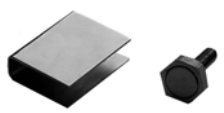
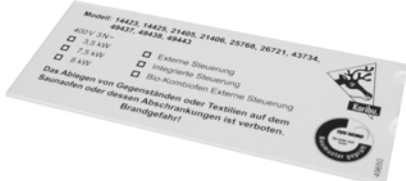

Art.Nr: Art.-nr. Art. N°: N° Art. Art. no. Art.N°:	Nr Nr. N° N° No. No.:	Bezeichnung Benaming Désignation Denominación Description Descrizione	Bild Afbeelding Illustration Dibujo Illustration Immagine	Länge Lengte Longueu r Long. Length Lungh.	Breite Breedte Largeur Ancho Width Largh.	Stärke Dikte Épaisseur Espesor Thick- ness Spess.	Material Materiaal Matériau Material Material Materiale	Stück Aantal Pièce Ctdad. Num- ber Q.tà
21814	I	Aufrechte Rahmen schräg Hoekstijlen afgeschuind Cadres verticaux inclinés Marco vertical inclinado Upright frame inclined Telaio verticale inclinata		1916	36	36	Leiste schräg Lat afgeschuind Plinthe inclinée Listón inclinado Ledge inclined Corrente trapezoidale	2
21825	J	Aufrechte Rahmen schräg Hoekstijlen afgeschuind Cadres verticaux inclinés Marco vertical inclinado Upright frame inclined Telaio verticale inclinata		1973	36	36	Leiste schräg Lat afgeschuind Plinthe inclinée Listón inclinado Ledge inclined Corrente trapezoidale	2
56718	K	Brett über Tür Plank boven deur Planche dessus de porte Tabla sobre la puerta Board over door Tavoletta sopra la porta		781	38	78	Brett Plank Planche Tabla Board Tavoletta	1
26580	M	Deckenleiste Deklat plafond		1308	18	45	Leiste Lat Plinthe Listón Ledge Corrente	2
21439	M	Plinthe de plafond Listón del techo		1206	18	45		2
21440	M	Cornice Correnti del soffitto		880	18	45		1
26581	N1	Dachplatte Dakplaat Panneau de toit Placa del tejado Roof plate Tavole del tetto		1338	666	55	Vormontiert Voorgemonteerd Prémonté Premontado pre-assembled Premontato	1
26582	N2	Dachplatte schräg Dakplaat afgeschuind Panneau de toit incliné Placa del tejado inclinado Roof plate inclined Tavola obliqua del tetto		1338	666	55	Vormontiert Voorgemonteerd Prémonté Premontado pre-assembled Premontato	1
26500	P	Tür incl. Beschläge Deur incl. hang- en sluitwerk Porte, garnitures comprises Puerta incl. guarniciones Door including fixtures Porta, incl. cerniere		1911	815	38	Vormontiert Voorgemonteerd Prémonté Premontado pre-assembled Premontato	1
48541	U	Brett Aufrecht Plank verticaal Planche verticale Tabla vertical Board upright Asse verticale		2000	17	58	Glattkant Gladde kant Angle lisse Borde liso smooth-edged Bordo levigato	2
48541	T	Brett Kranz Front/Seite Plank kranlijst front/zijkant Planche couronne devant/côté Tabla corona delantera /lateral Board face front/side Tavoletta marcapiano anteriore/laterale		2000	17	58	Glattkant Gladde kant Angle lisse Borde liso smooth-edged Bordo levigato	2
48541	T	Brett Kranz Seite Plank kranlijst zijkant Planche couronne côté Tabla corona lateral Board face side Tavoletta marcapiano laterale		2000	17	58	Glattkant Gladde kant Angle lisse Borde liso smooth-edged Bordo levigato	1
48544	T	Brett Kranz über Tür Plank kranlijst boven deur Planche couronne dessus de porte Tabla corona sobre la puerta		850	17	58	Glattkant Gladde kant Angle lisse Borde liso	1

Art.Nr: Art.-nr. Art. N°: N° Art. Art. no. Art.N°:	Nr Nr. N° N° No. N°:	Bezeichnung Benaming Désignation Denominación Description Descrizione	Bild Afbeelding Illustration Dibujo Illustration Immagine	Länge Lengte Longueu r Long. Length Lungh.	Breite Breedte Largeur Ancho Width Largh.	Stärke Dikte Épaisseur Espesor Thick- ness Spess.	Material Materiaal Matériau Material Material Materiale	Stück Aantal Pièce Ctdad. Num- ber Q.tà
		Tabla corona sobre la puerta Board face over door Tavoletta marcapiano sopra la porta					Borde liso  smooth-edged Bordo levigato	
48545	Q	Brett Aufrecht 45grad Plank verticaal 45 graden Planche verticale 45 degrés Tabla vertical 45 grados Board upright 45 degrees Asse verticale a 45°		2000	17	58	Glattkant Gladde kant Angle lisse Borde liso smooth-edged Bordo levigato	2
22044	R	Brett Aufrecht Einstieg Plank verticaal instap Planche verticale entrée Tabla vertical entrada Board upright entrance Asse verticale d'ingresso		2000	38	38	Glattkant Gladde kant Angle lisse Borde liso smooth-edged Bordo levigato	2
20799	W	Dachverbindungsleiste Dakverbindingsstrip Plinthe de raccordement du toit Listón de unión del tejado Roof joint ledge Correnti di collegamento del tetto		1920	3,5	20	Leiste Lat Plinthe  Listón Ledge Correnti	1
52064	L1	Liege Ligbank Banc		1309	550	90	Vormontiert Voorgemonteerd Prémonté	1
52066	L2	Banco Bench Panca		1309	250	90	Premontado pre-assembled Premontato	1
44004	L3	Liegenblende Afwerklát ligbank Rebord banc Cubierta del banco Bench covering Tavola di chiusura della panca		1309	19	90	Leiste Lat Plinthe Listón Ledge Correnti	2
40301	L5	Liegenhalterung Ligbankhouder Support de banc Soporte del banco		555	45	45	Leiste Lat Plinthe Listón	2
3863	L6	Support for bench Supporto della panca		250	45	45	Ledge Correnti	2
		Bank Distanzstück Bank afstandsstuk Banc pièce d'écartement Banco distanciador Bench spacer piece Distanziatore panca		550	15	45	Leiste Lat Plinthe Listón Ledge Correnti	2
26716		Bank Distanzstück Bank afstandsstuk Banc pièce d'écartement Banco distanciador Bench spacer piece Distanziatore panca		250	15	45	Leiste Lat Plinthe Listón Ledge Correnti	2
15498	O2	Ofenschutz Front Rück Kachelbeschermrekiye voor/achter Protection de poêle devant/derrière Protección del horno delantera/trasera Oven protection front rear Protezione della stufa anteriore e posteriore		565	18	95	Brett Plank  Planche  Tabla  Board Tavoletta	4
20930	O1	Ofenschutz Seite Kachelbeschermrekiye zijkant Protection de poêle côté Protección del horno lateral		480	18	95	Brett Plank  Planche	4

Art.Nr: Art.-nr. Art. N°: N° Art. Art. no. Art.N°:	Nr Nr. N° N° No. N°:	Bezeichnung Benaming Désignation Denominación Description Descrizione	Bild Afbeelding Illustration Dibujo Illustration Immagine	Länge Lengte Longueu r Long. Length Lungh.	Breite Breedte Largeur Ancho Width Largh.	Stärke Dikte Épaisseur Espesor Thick- ness Spess.	Material Materiaal Matériau Material Material Materiale	Stück Aantal Pièce Ctdad. Num- ber Q.tà
		Oven protection side Protezione laterale della stufa					Tabla Board Tavoletta	
24796	O3	Ofenschutzstütze Pootje kachelbeschermrekje Support de protection poêle Apoyo protección del horno		800	18	45	Leiste Lat	2
15493	O6	Oven protection support Supporti della protezione della stufa		800	28	58	Plinthe Listón Ledge Correnti	2
19130	O5	Abluftregelbrett Plankje regeling luchtafvoer Planche de régulation de l'air Tabla reguladora de la salida de aire Exhaust air control board Tavoletta di regolazione della ventilazione		300	18	95	Brett Plank Planche  Tabla  Board Tavoletta	1
26480	O9	Kabelleiste Afdeklát bedrading Plinthe à câbles Listón de cables Cable cover strip Listello per i cavi		1825	26	110	Brett Plank Planche Tabla Board Tavoletta	1

 Beschlagbeutel:	 Zak met onderdelen hang-en sluitwerk:	 Sachet garnitures:	 Bolsa de guarniciones	 Bag of fixtures:	 Sacchetto della ferramenta
Art.-Nr. Art.Nr. Art. N° N° Art. Art. no. Art. N°	Beschlag Beslag Garniture Guarnición Fixture Ferramenta	Größe Maat Taille Dimens. Size Dimens.	Bemerkung Opmerking Remarque Observación Remarks Nota	Stück Aantal Pièce Ctdad. Number Q.tà	
3686	Spax	4   30		20	
3687	Spax-schroeven	4   35		60	
21925	Vis Spax	4   40		350	
3688	Tornillo Spax	4   50		30	
9204	Spax joint	4,5   80		25	
26715	Viti a croce	6   90		80	
14014		6   60		20	
26285	Spax Kopflochgebohrt Spax-schroef met kopgat Vis Spax tête percée Tornillo Spax cabeza perforada Spax joint with drilled access hole Viti a croce a testa perforata	4,5   40		50	
26116	Abdeckkappe Afdekkapje Capuchon Tapa Cover cap Tappi			50	
14025	Dichtband Afdichttape Bande d'isolation Cinta aislante Sealing tape Nastro sigillante			10m	

22047	Türmagnetset Deurmagneetset Set d'aimant de porte Juego de imanes puerta Door magnet set Set serratura magnetica della porta				2
14018	Gewindeschraube mit Scheibe und Mutter Tapschroef met sluitring en moer Vis fileté avec rondelle et boulon Tornillo de rosca con arandela y tuerca Threaded screw with washer and nut Vite filettata con rondella e bullone	8	70	nur bei Modellen mit 3 Liegen alleen bij modellen met 3 ligbanken Seulement pour modèles à 3 bancs Sólo en modelos con 3 bancos only for models with three benches solo per i modelli con 3 panche	3
20803	Winkel Hoekijzer Équerre Ángulo Bracket Angolare				2
49870	TüV-Schild für Saunaofen inkl. 4 Schrauben				1

					
Was mit welchem Verbindungsmittel verbunden?	Wat wordt met welk verbindingsmiddel met elkaar verbonden?	Qu'est-ce qui est joint ensemble, et avec quels moyens de fixation ?	¿Qué se une a qué y con qué medio de unión?	What is joined to what with which fixture?	Cosa va fissato con cosa?

Elemente Elementen Éléments Elementos Element Elementi	Beschlag Beslag Garniture Guarnición Fixture Ferramenta		Stk. Aant. Pièce Ctda d Num ber Q.tà	insgesamt Totaal Total Total Total in tutto	∅ Voorbooring Voorboord Perceмент pretaladro pre-drilling diameter foro
Wandbohlen mit aufrechte Rahmen Wandplanken met hoekstijlen Madrier mural avec cadres verticaux Tablón pared con marco vertical Wall board with upright frame Assi delle pareti con il telaio verticale	Spax 6 x 90 Spax-schroeven Vis Spax Tornillo Spax Spax joint Viti a croce	jede 4.Bohle pro Bohlenende Bohlenende Elke 4e plank per plankeinde tous les 4 madriers par extrémité de madrier cada cuarto tablón por extremo de tablón per board end, every fourth board ogni 4 assi, per ciascuna estremità dell'asse	2	80	5,5
	Spax 4 x 40 Spax-schroeven Vis Spax Tornillo Spax Spax joint Viti a croce	pro Bohlenende per plankeinde par extrémité de madrier por extremo del tablón per board end per ciascuna estremità	2	288	3,5

Elemente Elementen Eléments Elementos Element Elementi	Beschlag Beslag Garniture Guarnición Fixture Ferramenta		Stk. Aant. Pièce Ctda d Num ber Q.tà	insgesamt Totaal Total Total Total in tutto	Ø Vorbohrung Voorge- boord Percement pretaladro pre-drilling diameter foro
Aufrechte Rahmen schräg miteinander (nur bei Eckeinstieg) Afgeschuinde hoekstijlen met elkaar (alleen bij hoekinstap) Cadres verticaux inclinés ensemble (seulement pour entrée d'angle) Marcos verticales inclinados entre si (sólo en entrada angular) Upright frames inclined relative to each other (only for corner entrance) Telai verticali obliqui tra loro (solo per ingresso ad angolo)	Spax 4,5 x 80 Spax-schroeven Vis Spax Tornillo Spax Spax joint Viti a croce	pro Stück per stuk par pièce por unidad per piece per ciascun pezzo	5	10	4
Tür mit Wandelement Deur met wandelement Porte avec élément mural Puerta con elemento de la pared Door with wall element Porta con gli elementi delle pareti	Spax 4,5 x 80 Spax-schroeven Vis Spax Tornillo Spax Spax joint Viti a croce	pro Rahmenseite per raamwerkkant par côté de cadre por lado del marco por frame side Per ciascun lato del telaio	3	6	4
Brett über Tür mit aufrechten Rahmen schräg (nur bei Eckeinstieg) Plank boven deur met afgeschuinde hoekstijlen (alleen bij hoekinstap) Planche dessus de porte avec cadre vertical incliné (seulement pour entrée d'angle) Tabla sobre la puerta con marco vertical inclinado (sólo en entrada angular) Board over door with upright frame inclined (only for corner entrance) Tavoletta sopra la porta con telaio verticale obliquo (solo per ingresso ad angolo)	Spax 4,5 x 80 Spax-schroeven Vis Spax Tornillo Spax Spax joint Viti a croce	pro Seite per kant par côté por lado per side per ciascun lato	2	4	4
Deckenleisten mit Wandelementen Deklat plafond met wandelementen Plinthes de plafond avec éléments muraux Listones del techo con elementos de pared Cornices with wall elements Correnti del soffitto con gli elementi delle pareti	Spax 4 x 40 Spax-schroeven Vis Spax Tornillo Spax Spax joint Viti a croce	pro Leiste per afdeklát par plinthe por listón per ledge per ciascun listello	5	25	3,5
Dach mit Deckenleisten Dak met deklatten plafond Toit avec plinthes de plafond Tejado con listones del techo Roof with cornices Tetto con i listelli del soffitto	Spax 4 x 50 Spax-schroeven Vis Spax Tornillo Spax Spax joint Viti a croce	pro Dachseite per dakkant par côté du toit por lado del techo per roof side per ogni lato del tetto	3	18	3,5
Ofenschutz Kachelbeschermekje Protection de poêle Protección del horno Oven protection Protezione della stufa	Spax 4 x 35 Spax-schroeven Vis Spax Tornillo Spax Spax joint Viti a croce	pro Ecke per hoek par angle por esquina per corner per ciascun angolo	2	16	3,5
Ofenschutzstützen an Ofenschutz Pootjes aan kachelbeschermekje Supports de protection de poêle sur protection de poêle Apoyo protección del horno a la protección del horno Oven protection support for oven protection Supporti delle protezioni della stufa con le protezioni della stufa	Spax 4 x 35 Spax-schroeven Vis Spax Tornillo Spax Spax joint Viti a croce	pro Verbindung per verbinding par raccord por unión per joint per ogni collegamento	2	16	3,5

Elemente Elementen Eléments Elementos Element Elementi	Beschlag Beslag Garniture Guarnición Fixture Ferramenta		Stk. Aant. Pièce Ctda d Num ber Q.tà	insgesamt Totaal Total Total Total in tutto	Ø Vorböhrung Voorge- boord Percement pretaladro pre-drilling diameter foro
Kabelkanalabdeckung mit Wandelement Afdekking kabelgoot met wandelement Canal de couverture des câbles avec élément mural Cubierta del canal de cable con elemento de la pared Cable channel covering with wall element Rivestimento scanalato dei cavi con l'elemento della parete	Spax 4 x 35 Spax-schroeven Vis Spax  Tornillo Spax  Spax joint Viti a croce	nach Bedarf zo veel als odig selon le besoin  según la necesidad  as required se necessario		bis tot 4 jusqu'à  hasta  up to fino a	3,5
Abluftregelbrett an Wand Plankje regeling luchtafvoer aan de wand Planche de régulation de l'air sur mur Tabla de regulación de salida de aire a la pared Exhaust air control board on wall Tavoletta di regolazione della ventilazione con la parete	Spax 4 x 50 Spax-schroeven Vis Spax Tornillo spax Spax joint Viti a croce		1	1	3,5
Türmagnethalter mit Türrahmen Deurmagneethouder met deurkozijn Support d'aimant de porte avec cadre de porte Soporte magnético puerta con marco puerta Door magnet holder with door frame Serratura a magnete con lo stipite della porta	Spax 4 x 50 Spax-schroeven Vis Spax Tornillo Spax Spax joint Viti a croce	pro Stk per stuk par pièce por unidad per piece per pezzo	2	4	3,5
Brett aufrecht und Kranzleisten mit Saunakörper  Verticale plank en kranlijst met saunacabine  Planche verticale et plinthes de couronne avec corps du sauna Tabla vertical y listones de corona con el cuerpo de la sauna Board upright and cornice ledges with sauna body  Asse verticale e listelli del marcapiano con il corpo della sauna	Spax Kopflochgebohrt mit Abdeckkappen Spax-schroef met koggat en afdekkapjes Vis Spax tête percée avec capuchon Tornillo Spax de cabeza perforada con tapa Spax joint with drilled access hole and cover caps Viti a croce con foro e tappi	pro Stk  per stuk  par pièce  por unidad  per piece  per pezzo	5	45	4
Liegenhalterungen mit Wand Ligbankhouders met wand Supports de banc avec mur Soporte del banco a la pared Supports for benches with wall Supporti delle panche alla parete	Spax 6 x 60 Spax-schroeven Vis Spax Tornillo Spax Spax joint Viti a croce	pro Halterung per houder par support por soporte per support per ciascun supporto	3	12-15	5,5
Liege mit Wand (durch Bankdistanzstück) Ligbank met wand (m.b.v. bankafstandsstuk) Banc avec mur (par la pièce d'écartement) Banco a la pared (mediante distanciador del banco) Bench with wall (through bench spacer piece) Panca con la parete (tramite il distanziatore)	Spax 6 x 60 Spax-schroef Vis Spax Tornillo Spax  Spax joint Viti a croce	pro Stk per stuk par pièce por unidad  per piece per pezzo	3	12	5,5









					
<p><b>Allgemein:</b> Bitte beachten Sie, das Sie sämtliche Schraubverbindungen vorbohren müssen, um zu verhindern das sich das eingesetzte Holz spaltet. Welches Verbindungsmittel wo eingesetzt wird entnehmen Sie der Tabelle: „Was wird mit welchem Verbindungsmittel miteinander verbunden?“. Dort finden Sie auch die Durchmesser der zu setzenden Vorbohrungen. Die Seitenwände sollten mit Abstand zur Wand montiert werden, damit man die Eckverbindung von außen verschrauben kann. Wenn alle Seitenwände montiert sind kann der Saunakörper an die Wand geschoben werden. Halten Sie jedoch mindestens 10cm Wandabstand ein, um eine lange Lebensdauer Ihrer Sauna zu gewährleisten. Die Seitenwände müssen mit der Wasserwaage ausgerichtet werden. Bitte bauen Sie die Sauna im rechten Winkel auf. Durch die Charakteristik Ihrer Sauna, einzelne Bohlen übereinanderzuschichten, kann es zu Höhenunterschieden in den Wänden kommen. Diese sind unerheblich, da Ihre Sauna durch den oberen Kranz eine einheitliche Höhe erhält.</p>	<p><b>Algemeen:</b> Let op dat u alle schroefverbindingen moet voorboren om te voorkomen dat het gebruikte hout splijt. Welk verbindingsmiddel waar wordt toegepast, vindt u in de tabel: „Wat wordt met welk verbindingsmiddel met elkaar verbonden?“. Daar vindt u ook de diameters van de voor te boren gaten. De zijwanden moeten op enige afstand van de muur worden gemonteerd zodat de hoekverbinding van buitenaf kan worden geschroefd. Als alle zijwanden zijn gemonteerd, kan de saunacabine naar de muur worden geschoven. Houd echter een afstand tot de muur van ten minste 10 cm om een lange levensduur van uw sauna te waarborgen. De zijwanden moeten m.b.v. een waterpas worden afgesteld. Zorg ervoor dat de sauna haaks wordt opgebouwd. Door de karakteristieke bouw van uw sauna met elkaar overlappende planken kunnen er hoogteverschillen bij de wanden voorkomen. Deze zijn van geen belang omdat uw sauna door de kranlijst bovenop een uniforme hoogte krijgt.</p>	<p><b>Généralités :</b> Veuillez observer que vous devez percer auparavant l'ensemble des fixations à vis afin d'éviter que le bois utilisé ne se fende. Pour savoir quel moyen de fixation est utilisé à quel endroit, veuillez consulter le tableau « Qu'est-ce qui est joint ensemble, et avec quels moyens de fixation ? ». Vous y trouverez aussi le diamètre des percements à effectuer. Les murs latéraux devraient être montés avec une certaine distance par rapport au mur pour pouvoir visser le raccord d'angle de l'extérieur. Lorsque tous les murs latéraux sont montés, le corps du sauna peut être poussé vers le mur. Laissez cependant une distance de 10 cm par rapport au mur afin de garantir une durée de vie plus longue à votre sauna. Les murs latéraux doivent être dressés à l'aide d'un niveau. Veillez à construire le sauna en angle droit. La superposition des madriers, particularité de votre sauna, peut provoquer des différences de hauteur des murs. Celles-ci sont négligeables dans la mesure où la couronne assure au sauna une hauteur uniforme.</p>	<p><b>Generalidades:</b> No olvide que debe preperforar todas las uniones atornilladas para evitar que la madera se abra. De la tabla se desprende donde se utiliza cada medio de unión: "¿Qué se une entre sí y con qué medio de unión?": Ahí, usted encuentra también los diámetros de los pretaladros a realizar. Las paredes laterales deberían montarse con distancia a la pared para que se puedan atornillar las uniones de las esquinas. Cuando se hayan montado todas las paredes laterales, el cuerpo de la sauna puede correrse a la pared. Si bien, mantenga una distancia mínima a la misma de 10 cm para asegurar una larga vida útil de su sauna. Las paredes laterales se han de alinear con el nivel de albañil. Monte la sauna en ángulo recto. Por las características de su sauna, diferentes tablonos sobrepuestos, se pueden producir diferencias de altura en las paredes. Éstas carecen de importancia dado que su sauna recibe una altura unitaria por la corona superior</p>	<p><b>General:</b> Please note that it is necessary to pre-drill all screw connections in order to prevent splitting of the wood used. The table "What is joined to what with which connecting devices?" describes where which fixtures are used. There you will also find the diameters of for the pre-drilling steps. The side walls should be installed at a distance from the wall, so that the corner joint can be screwed down from the outside. When all side walls are installed, you can push the sauna up to the wall. However, maintain a distance of at least 10cm to the wall in order to ensure a long life for your sauna. Align the side walls with the spirit gauge. Make certain to erect the sauna strictly vertically. Due to the sauna characteristics, with individual boards over one another, differences in the height of the walls may arise. This is of no importance, since the upper face ensures that your sauna has a uniform height.</p>	<p><b>Generalità:</b> Si raccomanda di preforare sempre prima di avvitare, in modo da evitare che il legno si rompa. Nella tabella si può vedere quali viti ed accessori si debbano di volta in volta usare per collegare i pezzi tra loro. „Quali parti vanno collegate tra loro e con quali mezzi?“ Vengono indicati anche i diametri dei fori che si devono eseguire. Le pareti laterali non vanno montate troppo vicino alle pareti della stanza, in modo da poter avvitare gli angoli dall'esterno. Quando tutte le pareti laterali sono montate il corpo della sauna può essere avvicinato alla parete della stanza. Mantenere almeno 10 cm di distanza dalla parete, per assicurare una maggiore durata della sauna. Le pareti laterali vanno orientate con la livella a bolla. Montare la sauna a squadra. A seconda delle caratteristiche della Sauna si potrebbero avere differenze di altezza delle pareti a seguito del sovrapporsi delle assi. Ciò è inevitabile, in quanto la sauna ottiene un'altezza omogenea con il marcapiano superiore.</p>
<p><b>Reihenfolge Aufbau:</b> Als erstes sollten Sie die Türscheibe nach anliegender Anleitung mit dem Türrahmen verbinden. Dann folgt die Montage des Saunagrundkörpers mit Leistenset sowie Türgriff. Bauen Sie danach die</p>	<p><b>Volgorde opbouw:</b> Als eerste moet de glazen deur volgens de bijgaande handleiding aan het deurkozijn worden bevestigd. Daarna volgt de montage van de saunacabine met de afdeklatten en de handgreep van de deur. Monteer daarna</p>	<p><b>Ordre de montage:</b> Monter d'abord la vitre de la porte sur le cadre de porte selon la notice de montage jointe. Ensuite vient le montage du corps du sauna avec le set de plinthes ainsi que la poignée de porte. Procéder enfin à</p>	<p><b>Secuencia de montaje:</b> Primero una la hoja de la puerta con el marco según las instrucciones adjuntas. Después realice el montaje del cuerpo base de la sauna con el juego de listones así como la empuñadura. Posteriormente monte el</p>	<p><b>Assembly procedure:</b> Firstly, you should attach the door plate to the door frame as described in the accompanying instructions. Then assemble the sauna cabin with the ledge set and the door handle. This is followed by the interior equipment, such as</p>	<p><b>Montare seguendo le istruzioni:</b> Per prima cosa fissare il vetro della porta agli stipiti della porta, come indicato nelle istruzioni allegate. Segue quindi il montaggio del corpo della sauna, con il set di listelli e la maniglia della porta.</p>

					
Inneneinrichtung wie Ofenschutz, Liegen usw..	de onderdelen van het interieur zoals het kachelbeschermerkje, de ligbanken enz.	l'assemblage de l'aménagement intérieur tel que protection du poêle, bancs etc.	equipo interior, como protección del horno, bancos, etc.	the oven protection, benches, etc.	Quindi arredare l'interno, con la protezione per la stufa, le panche ecc.
<b>Abb.: --&gt; Abbildung</b>	<b>Afb.: --&gt; afbeelding</b>	<b>Fig.: --&gt; Figure</b>	<b>Ilust.: → Ilustración</b>	<b>Fig.: --&gt; Figure</b>	<b>Imm.:--&gt;Immagine</b>
<b>Abb.: 1</b> Hier ist eine bemaßte Draufsicht dargestellt.	<b>Afb.: 1</b> Hier is een overzichtstekening met maten weergegeven.	<b>Fig.: 1</b> Aperçu général métré.	<b>Ilust. : 1</b> Aquí se representa una vista en planta dimensionada	<b>Fig. 1</b> This figure is a top view showing the dimensions.	<b>Imm. 1</b> Qui viene rappresentata una pianta con le quote.
<b>Abb.: 2</b> Die Wände bestehen aus 38mm Blockbohlen (Pos. A-E) mit Nut und Feder. Diese werden an den Saunaecken durch Pos. H untereinander verbunden. Jede Bohle wird mit 2 Spax an jedem Ende mit Pos. H verbunden. Im Bereich der Tür werden die Frontbohlen mit Pos.I verbunden. Jede Bohle wird mit 2 Spax mit Pos. I verbunden. Beim Schrauben auf gleiche Höhe der Bohlen achten. Bitte beim Saunaaufbau die Sauna immer überprüfen ob die Sauna im Lot ist und die Wände rechtwinklig zueinander verlaufen. Lage der Pos.D: als 2. Bohle von unten Lage Pos. G: in der Rückwand als 6. Bohle von unten. <b>Achtung!</b> Bitte jede 4.Bohle mit den größeren Schrauben befestigen. dabei mit in die andere Bohle schrauben (Detail)	<b>Afb.: 2</b> De wanden bestaan uit 38 mm planken (pos. A-E) met veer en groef. Deze worden bij de hoeken van de sauna via pos. H met elkaar verbonden. Elke plank wordt met 2 spax-schroeven op elk uiteinde met pos. H verbonden. Ter hoogte van de deur worden de voorwandplanken verbonden met pos. I. Elke plank wordt met 2 spax-schroeven verbonden met pos. I. Let bij het schroeven op een gelijke hoogte van de planken. Controleer bij de montage van de sauna altijd of deze in het lood staat en de wanden haaks op elkaar staan. Plaats van pos. D: als 2° plank van onderen Plaats pos. G: in de achterwand als 6° plank van onderen. <b>Let op!</b> Bevestig a.u.b. elke 4e plank met de grotere schroeven. Daarbij tevens in de andere plank schroeven (detail)	<b>Fig. : 2</b> Les murs sont composés de madriers de 38 mm (pos. A-E) avec rainure et languette. Ils sont reliés émité à la pos. H par 2 entre eux aux angles du sauna par la pos. H. Chaque madrier est relié à chaque extrémité spax. Dans la zone de la porte, les madriers frontaux sont assemblés à la pos. I. Chaque madrier est assemblé à la pos. I par 2 vis spax. Veiller à ce que les madriers soient à une hauteur identique lors du vissage. Durant le et que les murs sont tous à angles droits. Situation de la pos. D : comme 2ème madrier à partir du bas Situation pos. G : dans le mur arrière, comme 6ème madrier à partir du bas. <b>Attention</b> montage, vérifier régulièrement que le sauna est d'aplomb: Fixer chaque 4ème madrier avec les vis plus grosses et visser deux madriers ensemble (détail).	<b>Ilust.: 2</b> Las paredes constan de tablones en bloque de 38 mm (Pos. A-E) con lengüeta y ranura. Éstos se unen a las esquinas de la sauna entre sí por la posición H. Cada tablón se une a cada esquina con Pos. H mediante 2 Spax. En la zona de la puerta, los tablones delanteros se unen con la Pos. I. Cada tablón se une con 2 Spax con Pos. I. Al atornillar, cerciorarse que los tablones estén a la misma altura. Al montar la sauna comprobar siempre si está recta y que todas las paredes formen ángulos rectos. Situación de la Pos. D: como 2° tablón desde abajo Situación de la Pos. G: en la pared posterior como 6° tablón desde abajo. <b>Atención!</b> Fijar cada 4° tablón con el tornillo más grande. Fijar este tablón con el otro. (Detalle)	<b>Fig. 2</b> The walls consist of 38 mm block boards (pos. A-E) with tongue and groove. These are joined under each other at the corners of the sauna by pos. H. Each board is attached with two Spax joints at each end with pos. H. In the area of the door the front boards are joined with pos. I. Attach each board with two Spax joints to pos. I. Make certain to attach the screws at the same height to the boards. When erecting the sauna, always make certain that it is standing upright and the walls are perpendicular to each other. Location of pos. D: as second board from bottom Location of pos. G: in rear wall as sixth board from bottom. <b>Attention!</b> Attach each fourth board with the large screws. Drive the screws into the other board (Detail).	<b>Imm. 2</b> Le pareti sono fatte di assi da 38 mm (pos. A-E) ad incastro. Esse vengono collegate tra loro agli angoli della sauna con gli elementi in pos. H. Ogni asse viene fissata con 2 viti a croce ad ognuna delle sue estremità con l'elemento H. Nella zone della porta le assi frontali vanno fissate all'elemento Pos. I. Ogni asse va fissata con Pos. I con 2 viti a croce. Nell'avvitare fare attenzione a che le assi siano alla stessa altezza. Durante la costruzione della Sauna controllare sempre che essa sia a piombo e che le pareti siano ad angolo retto tra loro. Posizione dell'elemento Pos. D: seconda asse da sotto Posizione dell'elemento Pos. G: nella parete posteriore, 6° asse da sotto. <b>Attenzione!</b> Ad ogni 4.a asse utilizzare una vite più grossa per il fissaggio. Avvitare così anche nell'altra asse (dettaglio)
<b>Abb.: 3</b> Alle Bohlen aufschichten und verschrauben. Bitte auf gleiche Höhe der einzelnen Bohlenreihen achten. Damit die Bohlen fest aufeinandersitzen mit einem Gummihammer die Bohlen fest aufeinander bringen. Achtung: Die Pos H und I ist nicht so hoch wie eine fertige Wand. Im Bereich der Tür Pos.	<b>Afb.: 3</b> Alle planken aanbrengen en vastschroeven. Let op de gelijke hoogte van de verschillende rijen planken. Attentie: pos. H en I zijn niet zo hoog als een kant en klare wand. Schroef ter hoogte van de deur pos. J vast. Om ervoor te zorgen dat de planken stevig op elkaar zitten dient u de planken met een rubberhamer	<b>Fig.: 3</b> Superposer tous les madriers et les visser. Veiller à ce que les rangs de madriers atteignent la même hauteur. Donner quelques coups de marteau en caoutchouc afin d'obtenir une superposition solide des madriers. Attention : les pos. H et I ne sont pas aussi hautes que le mur terminé. Visser la pos. J	<b>Ilust.: 3</b> Sobreponer todos los tablones y atornillarlos. Cerciorarse que todas las líneas de tablones tengan la misma altura. Para que los tablones queden bien fijados unos sobre otros, ayudarse de una maza de goma. Atención: Las Pos H e I no son tan altas como una pared terminada. Atornillar Pos. J en	<b>Fig. 3</b> Stack all boards and attach with the screws. Make certain of the same height in the different rows of boards. In order to ensure that the boards lie firmly over each other, use a rubber hammer when laying the boards over each other. Attention: Pos. H and I are not as high as an assembled wall	<b>Imm. 3</b> Disponere tutte le assi ed avvitarle. Controllare che le singole file di assi siano alla stessa altezza. Per fissare bene le assi una sull'altra farle entrare bene negli incastri con un martello di gomma. Attenzione: Le Pos. H e I non vanno disposte alla stessa altezza della parete finita.

					
J anschrauben.	stevig op elkaar te slaan. Let op: pos. H en I zijn niet zo hoog als een kant en klare wand. Schroef ter hoogte van de deur pos. J vast.	dans la zone de la porte.	la zona de la puerta	Screw down in the area of the door - pos. J.	Nella zona della porta avvitare Pos. J.
<b>Abb.: 4</b> Jetzt wird die fertig montierte Tür eingesetzt. Mit 3 Stk. Spax je Seite mit den Fronten befestigen. Bitte dafür die Vorbohrungen verwenden und diese danach mit den Abdeckkappen des Beschlagbeutels für die Tür verschließen. Über der Tür wird Pos.K montiert und mit 4 Spax mit den Positionen J verschraubt.	<b>Afb.: 4</b> Nu wordt de kant en klaar gemonteerde deur geplaatst. Met 3 stuks spax-schroeven per kant aan de voorwaddelen bevestigen. Gebruik daarvoor de voorgeboorde gaten en sluit deze daarna af met de sierdopjes uit de zak met hangen sluitwerkonderdelen voor de deur. Boven de deur wordt pos. K gemonteerd en met 4 spax-schroeven aan pos. J vastgeschroefd.	<b>Fig.: 4</b> Installer maintenant la porte déjà montée. Fixer avec les parties frontales avec 3 vis spax par côté. Utiliser les percements préalables et les fermer ensuite à l'aide des capuchons fournis dans le sachet de garnitures. Au-dessus de la porte, pos. K est montée et vissée avec les positions J avec 4 vis spax.	<b>Ilust.: 4</b> Ahora se coloca la puerta ya montada. Fijar con los delanteros con 3 Spax por lado. Por favor, utilice las perforaciones previas y cierrelas posteriormente con las tapas de la bolsa de guarniciones para la puerta. Montar la Pos. K sobre la puerta y atornillar con 4 Spax con las posiciones J.	<b>Fig. 4</b> Then set in the already assembled door. Attach the door frame with three 4.5 x 80 Spax joints to the front on each side. Use the pre-drilled holes and close these off afterwards with the cover caps from the bag of fixtures for the door. Pos. K is installed above the door and attached with four Spax joints to pos. J.	<b>Imm. 4</b> Ora inserire la porta già montata. Fissare alla parete frontale con 3 viti a croce per lato. Inserire le viti nei fori predisposti e quindi apporre gli appositi tappi che troverete nel sacchetto della ferramenta. Montare Pos. K sopra la porta ed avvitarlo a Pos. J con 4 viti a croce.
Pos. M mit je 5 Spax an den Wänden montieren. Oberkante Pos. M = Oberkante Pos. H. Darauf das Dichband kleben. Pos M im Türbereich passend einkürzen. Achtung! Unbedingt die Wände genau ausrichten!	Pos. M met telkens 5 spax-schroeven aan de wanden monteren. Bovenkant pos. M = bovenkant pos. H. Plak daarop het afdichttape. Pos. M ter hoogte van de deur pas maken. Attentie! Stel de wanden absoluut nauwkeurig af!	Monter pos. M sur les murs à l'aide de 5 vis spax respectivement. Rebord supérieur pos. M = rebord supérieur pos. H. Coller la bande d'isolation par-dessus. Ajuster en raccourcissant pos. M dans la zone de la porte. Attention! Les murs doivent être dressés avec exactitude!	Montar Pos. M con 5 Spax respectivamente a las paredes. Borde superior Pos. M = Borde superior Pos. H. Pegar sobre ellos cinta aislante. Acortar Pos M adecuadamente en el sector de la puerta. Atención: Es imprescindible orientar las paredes exactamente	Install pos. M with five Spax joints on the walls. The upper edge of pos. M must be flush with the upper edge of pos H. Cover over with sealing tape. Shorten pos. M in the area of the door as required. Attention! Make certain to exactly align the walls!	Montare Pos. M alle pareti con 5 viti ciascuna. Spigolo superiore dell'elemento Pos. M = Spigolo superiore dell'elemento Pos. H. Applicarvi il nastro sigillante. Accorciare adeguatamente Pos. M dalla parte della porta. Attenzione! Si raccomanda di orientare le pareti con precisione!
<b>Abb.: 5</b> Zuerst eine Dachplatte (Pos N1) auf Deckenleisten (Dichtband) legen, Dachverbindungsleiste (Pos W) in Nut der Dachplatte einschieben. Die nächste Dachplatte (Pos N2) einlegen. Die Dachplatten werden von unten mit den Deckenleisten verschraubt.  Pos. U und R und Q werden mit Schrauben auf den Ecken befestigt. An den Sichtseiten werden die Pos.T oben bündig mit Pos U, R und Q angebracht. Diese Leisten sind länger als benötigt geliefert.	<b>Afb.: 5</b> Leg eerst een dakplaat (pos. N1) op de deklatten (afdichttape), schuif de dakverbindingsstrip (pos. W) in de groef van de dakplaat. Breng de volgende dakplaat aan. De dakplaten worden van onderaf vastgeschroefd aan de deklatten voor het plafond.  Pos. U en R en Q worden met spijkers op de hoeken bevestigd. Aan de zichtzijden worden de pos. T aan de bovenkant vlak aanliggend met pos. U, R en Q vastgespijkerd. Deze latten zijn met een universele lengte geleverd.	<b>Fig. : 5</b> Poser d'abord un panneau de toit (pos. N1) sur les plinthes du plafond (bande d'isolation), introduire la plinthe de raccordement du toit (pos. W) dans la rainure du panneau de toit. Poser le panneau de toit suivant. Les panneaux de toit sont vissés par le bas aux plinthes du plafond.  Fixer les pos. U et R et Q à l'aide de vis avec capuchons sur les angles. Aux emplacements visibles, la pos. T et les pos. U, R et Q sont placées jointes à niveau dans	<b>Ilust.: 5</b> Poner primero una placa del tejado (Pos N1) sobre los listones del techo (cinta aislante). Introducir el listón de unión del tejado (Pos W) en la ranura de la placa del tejado. Las placas del tejado se atornillan por debajo con los listones del techo.  Las Pos. U, R y Q se fijan a las esquinas con los tornillos con las tapas. En las partes visibles, la Pos. T se dispone arriba y a ras con las Pos U, R y Q. Estos listones se suministran más largos de lo necesario. Siérrelos a la	<b>Fig. 5</b> Firstly lay a roof plate (pos. N1) onto the ceiling ledges (sealing tape) and push the roof joint ledge (pos. W) into the groove of the roof plate. Lay the next roof plate. Screw down the roof plates to the ceiling ledges from below.  Attach pos. U, R and Q with screws to the corners. On the visible sides, set pos. T flush with the upper end of pos. U, R and Q. These ledges are delivered longer than necessary. Saw them to the required length. In the top view showing the	<b>Imm. 5</b> Dapprima posare una tavola del tetto (pos. N1) sui listelli del soffitto (nastro sigillante), quindi inserire i listelli di collegamento del tetto (pos. W) nella scanalatura delle tavole del tetto. Posare la tavola del tetto successiva. Le tavole del tetto vanno avvitate da sotto ai correnti del soffitto.  Le Pos. U, R e Q vanno fissate sugli angoli e dotate di tappi. Sul lato a vista va fissato l'elemento Pos. T in modo che sopra sia a filo con gli elementi Pos. U, R e Q. Questi listelli

					
Sägen Sie diese das bei Ihnen erforderliche Maß. In der bemaßten Draufsicht (Abb.1) können Sie genauer erkennen, wie welche Leiste an die Sauna befestigt wird.	Zaag deze op de bij u benodigde lengte. In het bovenaanzicht met maten (afb. 1) kunt u precies zien hoe elke lat aan de sauna wordt bevestigd.	la partie supérieure. Ces plinthes sont livrées extra-longues, vous pouvez les découper à la longueur nécessaire. Pour voir quelles plinthes sont fixées au sauna : voir aperçu métré (fig. 1).	medida necesaria. En la vista en planta medida (Ilust. 1), usted puede reconocer exactamente con qué listón se fija a la sauna.	dimensions (Fig. 1) you can recognize better which ledge is attached to the sauna.	sono più lunghi del necessario. Segarli nella misura necessaria. Nello schema con le quote (imm. 1) si può vedere meglio quale listello va fissato sulla sauna e come.
<b>Abb.:L1</b> Liegenhalterungen montieren  Höhe: Die in der Zeichnung angegebenen Maße beachten (Fußboden bis Unterkante Liegenhalterung angegeben).	<b>Afb.: L1</b> Montage ligbankhouders.  Verticale positie / hoogte: zie de in de tekening aangegeven maten (vloer tot onderkant ligbankhouder).	<b>Fig.: L1</b> Monter les supports de bancs.  Hauteur : respecter les dimensions de l'illustration (du sol au bord inférieur support de banc indiqué).	<b>Ilust.: L1</b> Montar los soportes del banco.  Altura: Respetar las dimensiones indicadas en el dibujo. (Indicado suelo hasta borde inferior del soporte del banco)	<b>Fig. L1</b> Assembling the supports for the benches  Height: according to the dimensions given in the drawing (floor to lower edge of support for bench).	<b>Imm. L1</b> Montare i supporti delle panche.  Altezza: Osservare la misura indicata nel disegno (dal pavimento allo spigolo inferiore del supporto della panca).
<b>Abb. L2</b> Hier ist die Lage der Verschraubungen bei dargestellt.	<b>Afb. L2</b> Hier is de plaats van de schroefverbindingen bij de ligbankhouder weergegeven.	<b>Fig. L2</b> Illustration de la position des vissages.	<b>Ilust.: 2</b> Aquí se representa la situación de las atornilladuras.	<b>Fig. L2</b> This figure illustrates the positions of the screws of the support for the bench and for the stop block.	<b>Imm. L2</b> Qui sono indicati i punti dove vanno fissate le viti.
<b>Abb.:O1</b> Ofenschutz montieren.	<b>Afb.: O1</b> Montage kachelbeschermrekje.	<b>Fig. :O1</b> Monter la protection de poêle.	<b>Ilust.: O1</b> Montar la protección del horno.	<b>Fig. O1</b> Install the oven protection.	<b>Imm.: O1</b> Montare la protezione della stufa.
<b>Abb.:O2</b> Bringen Sie die Ofenschutzstützen an den Ofenschutz an. Die angegebenen Maße gegebenenfalls an den Ofen anpassen. Ofenschutz möglichst mittig vor das Wandelement mit der Zuluft (Front) stellen. Schrauben Sie es an diese Front an. (Beide Bretter die an der Wand sind anschrauben; X ... Lage Verschraubung) Ausnahme: Produktnummer: 85420 dort kommen die Schrauben in die Schmale Seite.  <b>Kabelleiste:</b> Wenn Sie die Elektrokabel in der Sauna vom Ofen zum Steuergerät und dann zum Dach verlegen, können Sie mit	<b>Afb.: O2</b> Monteer de pootjes aan het kachelbeschermrekje. Pas de aangegeven maten evt. aan de kachel aan. Zet het kachelbeschermrekje zoveel mogelijk midden vóór het wandelement met de luchttoevoer (front). Schroef het vast aan dit voorwanddeel. (Beide plankjes die tegen de wand komen vastschroeven; X ... plaats schroeven). Uitzondering: productnummer: 85420, daar komen de schroeven in de smalle kant.  <b>Afdeklát bedrading:</b> Als u de snoeren in de sauna van de kachel naar de regelaar en vervolgens naar het dak legt, kunt u achter deze afdeklát de bedrading wegwerken. In de lat zijn	<b>Fig. : O2</b> Installer les supports sur la protection du poêle. Adapter au poêle les dimensions données si nécessaire. Placer le plus possible la protection de poêle au centre devant l'élément mural avec l'aération (façade). Vissez-la sur cette façade. (Visser les deux planches du mur ; X ... position de vissage). Exception : produit n° 85420, fixation par vis sur le côté étroit.  <b>Plinthes à câbles:</b> Si vous posez les câbles électriques, dans le sauna, allant du poêle vers l'appareil de commande et ensuite vers le toit, vous pouvez recouvrir ces câbles avec la plinthe à câbles. La plinthe a plusieurs fraisages afin de pouvoir être	<b>Ilust.: O2</b> Coloque los apoyos de la protección del horno en la protección. Adaptar las medidas indicadas al horno si es necesario. Colocar la protección del horno lo más centradamente posible delante del elemento de la pared con la entrada de aire (delantero). Atorníllela a la parte delantera. (Atornillar ambas tablas que están en la pared; X ... posición de atornillado) Excepción: número de producto 85420. Aquí se ponen los tornillos en la parte delgada. <b>Listón para cables:</b> Si usted coloca el cable eléctrico en la sauna desde el horno hasta el aparato de mando y después hasta el	<b>Fig. O2</b> Bring the oven protection support up to the oven protection. Adapt the size of the oven if necessary. Place the oven protection as well centred as possible in front of the wall element with the air inlet (front) and screw down to this front (attach both boards on the wall; X ... position of screw attachment) Exception: product number: 85420 - here the screws are attached from the narrow side.  <b>Cable cover strip:</b> If you lay the electric cable in the sauna from the oven to the control unit and then to the roof, you can cover the cable with this cover strip. The cover strip has different millings, so	<b>Imm.: O2</b> Fissare i supporti delle protezioni della stufa alle protezioni della stufa. Eventualmente si dovrà adattare alla stufa le dimensioni delle protezioni. Disporre la protezione della stufa il più centralmente possibile rispetto all'elemento della parete con la presa d'aria (frontale). Avvitarla a questa parete frontale. (Avvitare entrambe le assi alla parete ; X ... Posizione viti) Eccezione: Numero prodotto: 85420 in questo caso le viti vanno avvitate sul lato corto.  <b>Listello per i cavi:</b> Quando nella sauna si posa il cavo elettrico che va dalla stufa al comando e quindi fino al

					
der Kabelleiste diese Kabel abdecken. Die Leiste hat verschiedene Fräsungen, damit diese für jede Ofenvariante angewendet werden kann. Verwenden Sie die Leiste so wie Sie diese benötigen.	verschillende sleuven gefreesd zodat deze voor elke kachelvariant kan worden gebruikt. Gebruik de lat al naar gelang de gekochte kachel.	utilisée pour chaque variante de poêle. Utilisez la plinthe comme vous en avez besoin.	techo, lo puede cubrir con el listón de cable. El listón tiene diferentes fresados para que pueda utilizarse en todas las variantes de horno. Utilice el listón tal y como usted lo necesita.	that it can be used with different oven models. Use the cover strip as required.	listello per i cavi. Il listello ha diverse scanalature, per essere utilizzabile con i diversi modelli di stufa. Utilizzare il listello a seconda delle necessità.
<b>Abb.:O3</b> Zeichnen Sie die Mitte des Abluftregelbrettchens an. Dies ist die Lage der Vorbohrung für die Schraube. Bohren Sie dort nun vor.	<b>Afb.: O3</b> Teken het midden van het plankje voor de regeling van de luchtafvoer aan. Hier moet het gaatje voor de schroef worden voorgeboord. Boor nu het gaatje voor.	<b>Fig.: O3</b> Marquez le milieu de la planchette de régulation de l'air. Ceci est la position du percement pour la vis. Percez ici un trou avant de visser.	<b>Ilust. O3</b> Marque el centro de la tablita de regulación de aire de salida. Ésta es la situación de la perforación previa para el tornillo. Haga aquí la perforación previa.	<b>Fig. O3</b> Mark the centre of the exhaust air control board. This is the position of the pre-drilling for the screw. Then carry out pre-drilling.	<b>Imm. O3</b> Segnare il centro della tavoletta di regolazione della ventilazione. In quel punto si dovrà forare la tavoletta per la vite. Eseguire il foro.
<b>Abb.:O4</b> Legen Sie das Abluftregelbrett mittig über beide Abluftöffnungen der Rückwand. Schrauben Sie es nun mit 1 Spax 4 x 30 an.	<b>Afb.: O4</b> Breng het plankje in het midden over beide luchtafvoeropeningen in de achterwand aan. Schroef het er nu met 1 spax-schroef 4x30 aan.	<b>Fig.: O4</b> Posez la planchette de régulation de l'air au milieu par-dessus les deux ouvertures d'écoulement de l'air du mur arrière. Vissez-la maintenant avec 1 vis spax 4 x 30.	<b>Ilust.: O4</b> Coloque la tabla de regulación de salida de aire en el centro sobre las aperturas de salida de aire de la pared posterior. Atorníllela con 1 Spax 4x30.	<b>Fig. O4</b> Place the exhaust air control board in the centre over the two exhaust air openings on the rear wall. Then attach, using one 4 x 30 Spax joint.	<b>Imm. O4</b> Disporre la tavoletta di regolazione della ventilazione in mezzo alle due aperture di ventilazione della parete posteriore. Avvitarla con una vite a croce 4 x 30.
<b>Abb.:O5-7</b> Hier ist die Funktionsweise des Brettes abgebildet. Regeln Sie damit die Abluft nach eigenen Wünschen.	<b>Afb.: O5-7</b> Hier is de werking van het plankje afgebeeld. Regel daarmee de luchtafvoer naar eigen wens.	<b>Fig.: O5-7</b> Ceci représente le mode de fonctionnement de la planche. Avec elle, réglez l'écoulement de l'air selon vos désirs.	<b>Ilust. O5-7</b> Aquí está representada la forma de funcionamiento de la tabla. Con ella, usted puede regular la salida de aire según su deseo.	<b>Fig. O5-7</b> This figure shows the functional principle of the board. Regulate the exhaust air according to your own wishes.	<b>Imm. O5-7</b> Viene illustrato il principio di funzionamento della tavoletta di regolazione della ventilazione. Con essa si può regolare a piacere la ventilazione.

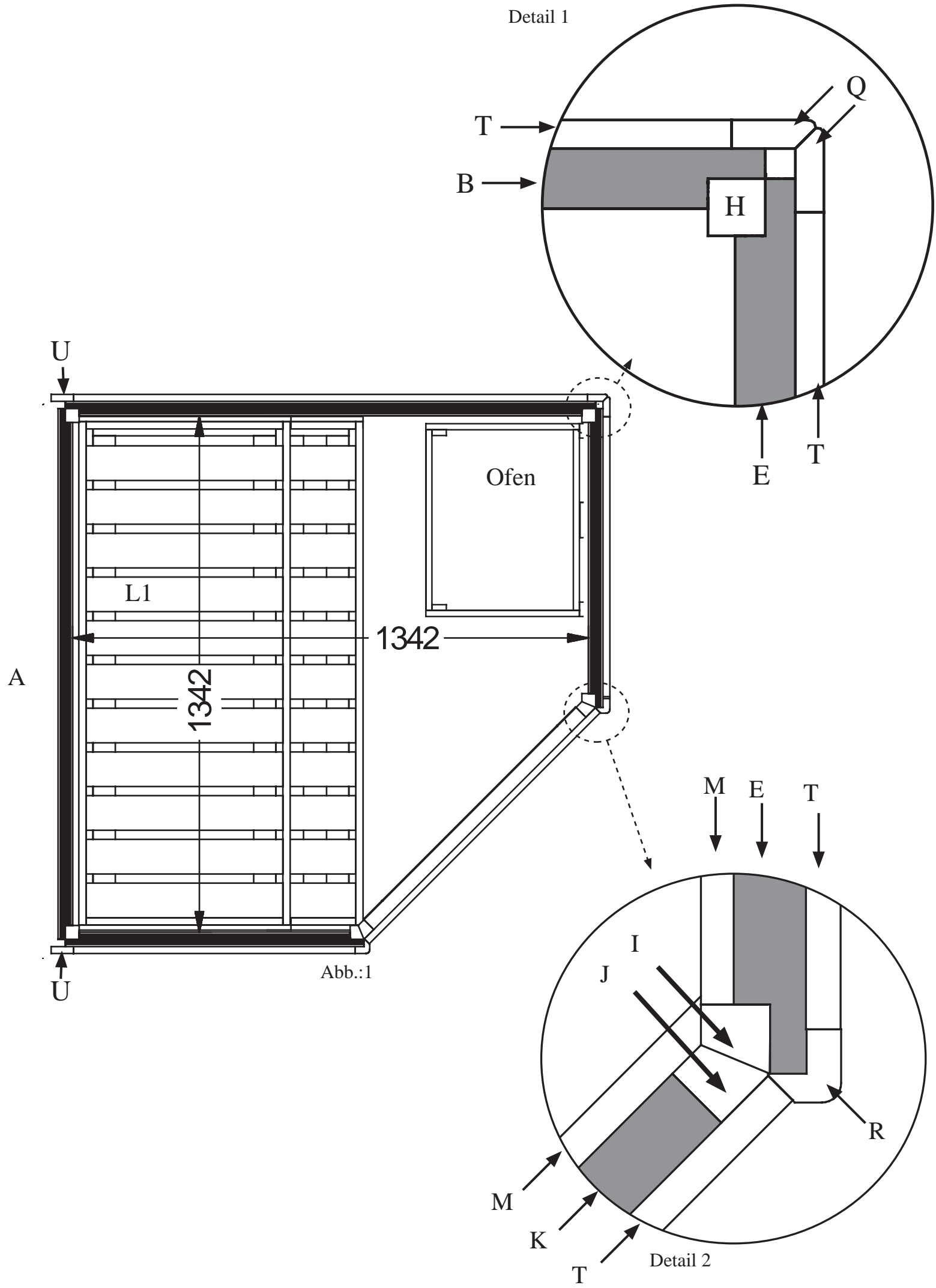

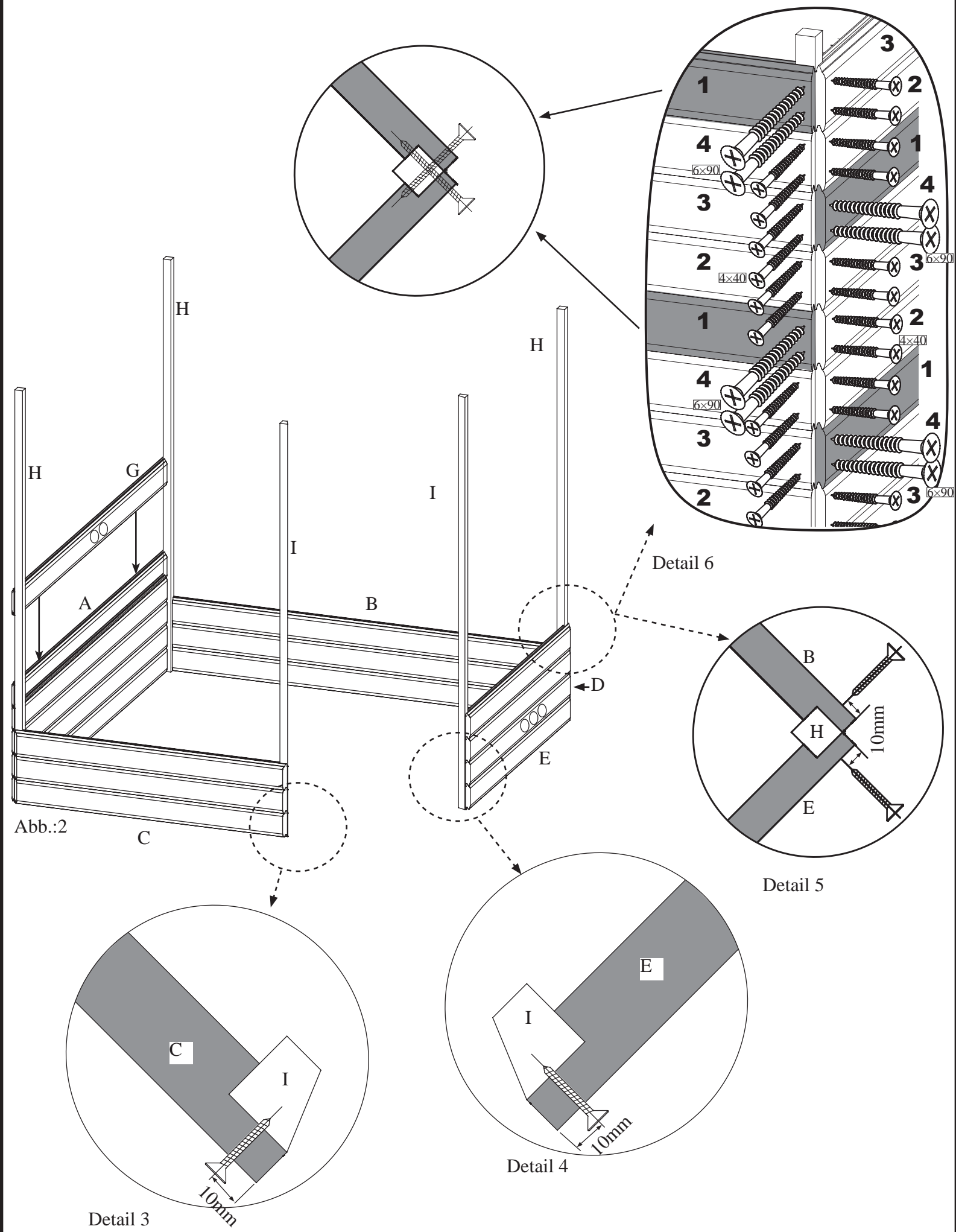

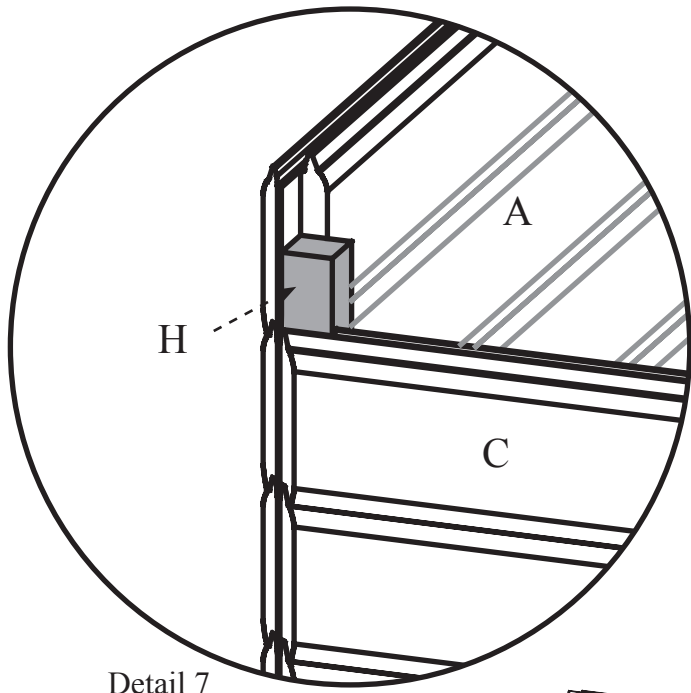

Detail 7



Abb.:3



Detail 8

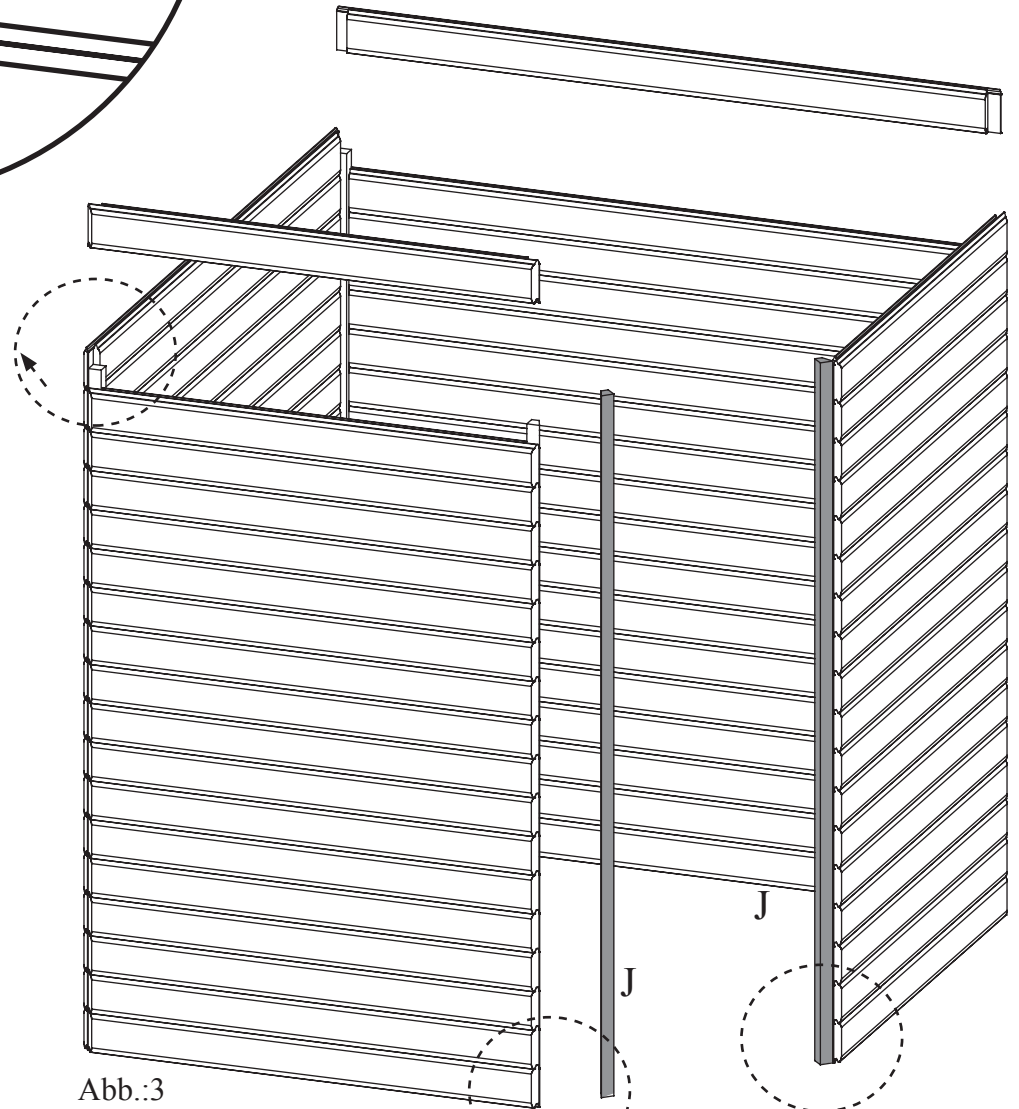
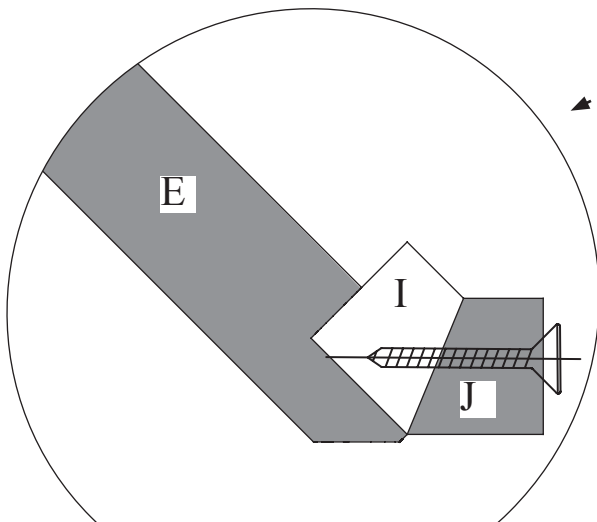
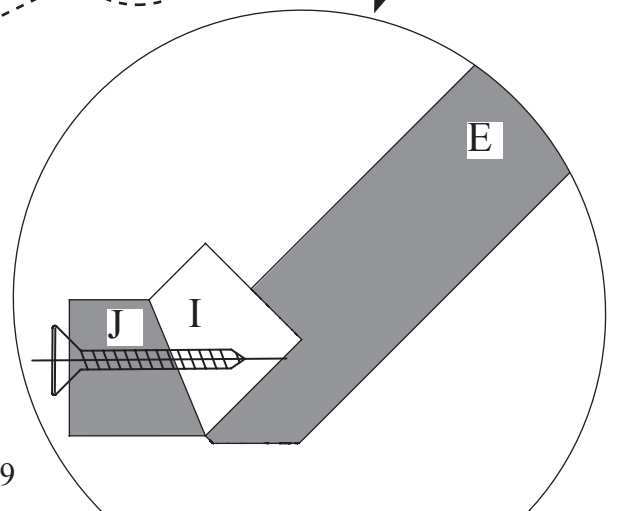

Detail 9



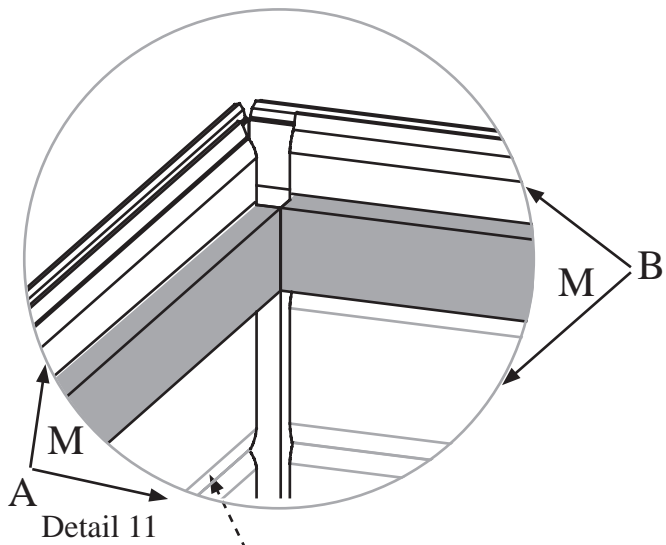

 Einbau Glastür  
 Montage porte en verre  
 Installation of glass door  
 Montage van de glazen deur  
 Montaje de la puerta de cristal  
 Installazione portello di vetro

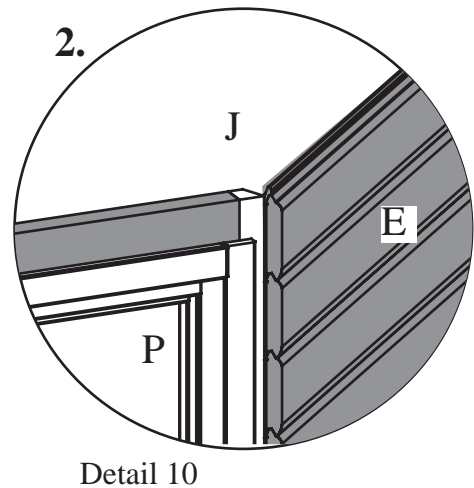
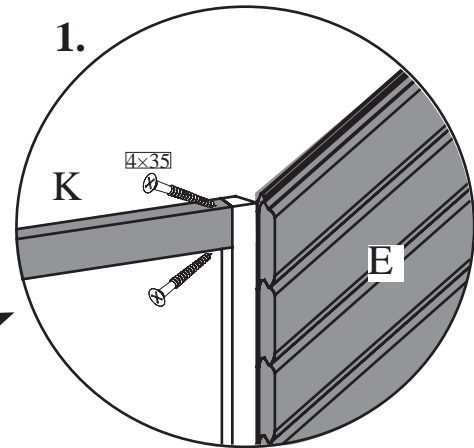
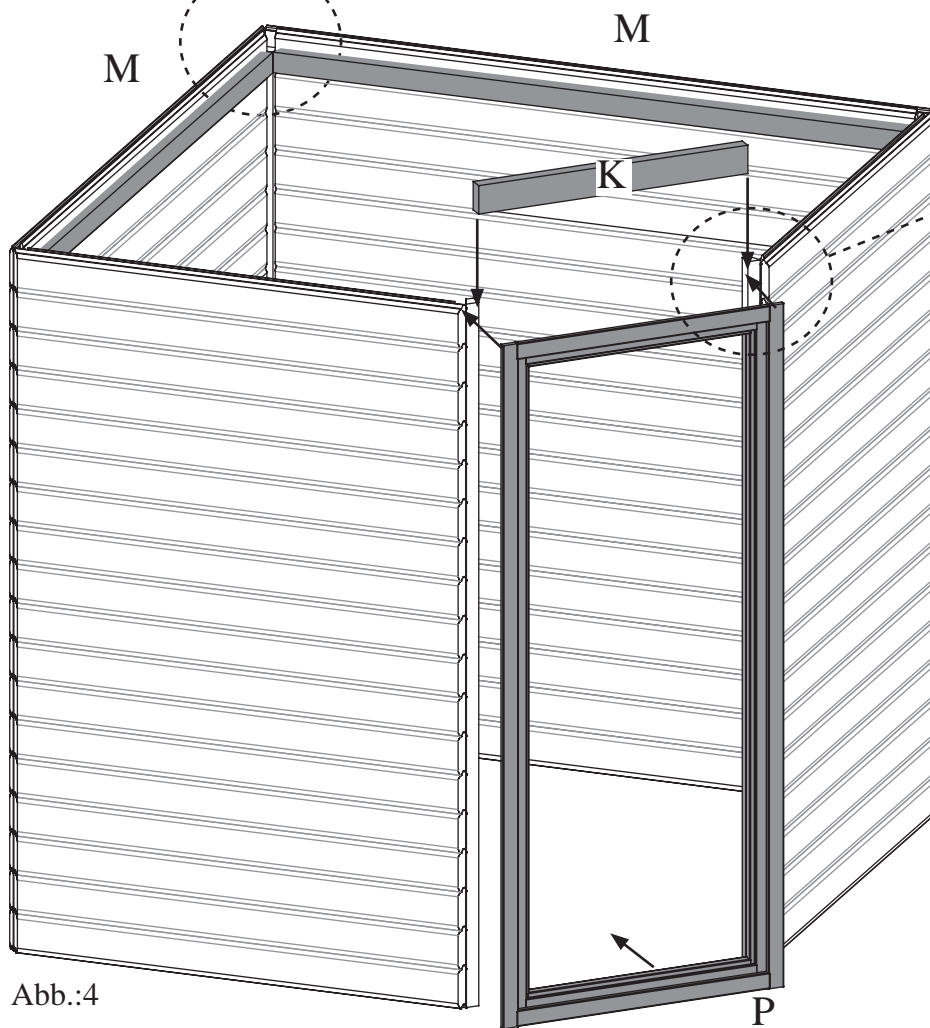

 — 
 

Detail 10

Abb.:4



Abb.:5



Abb.6

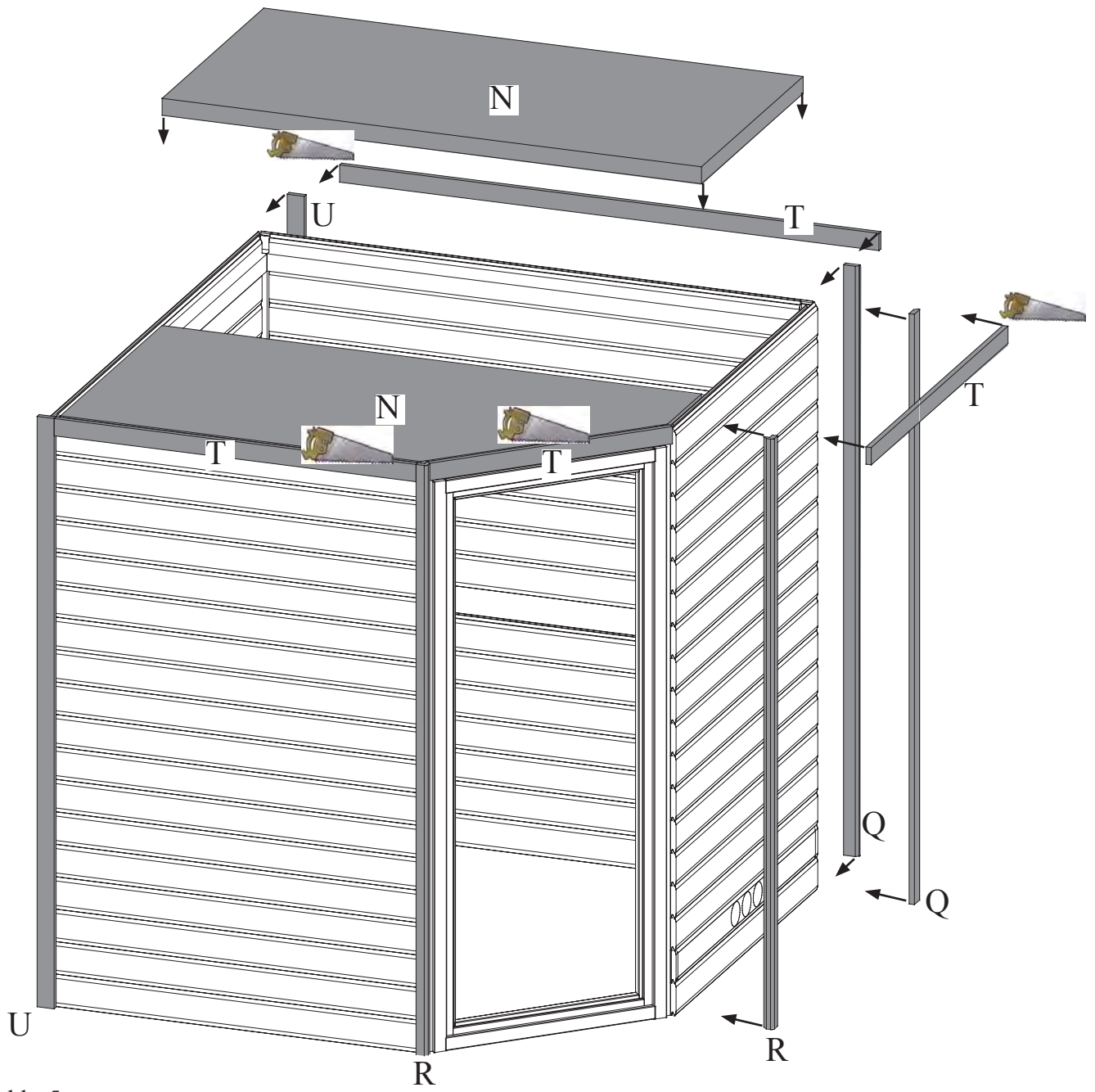

Abb.:L1



Abb.:L2

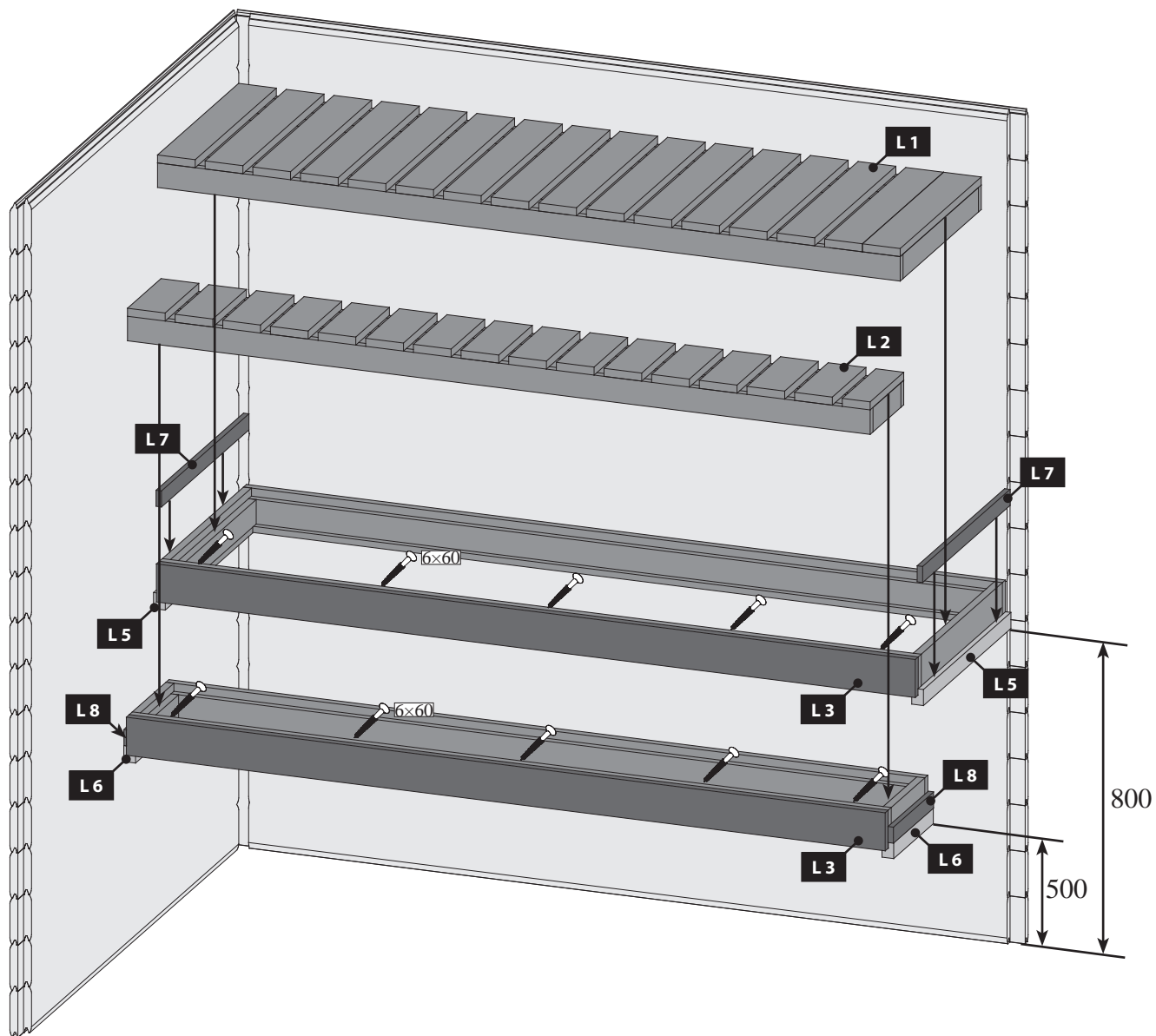

Abb.:L3

01 2x

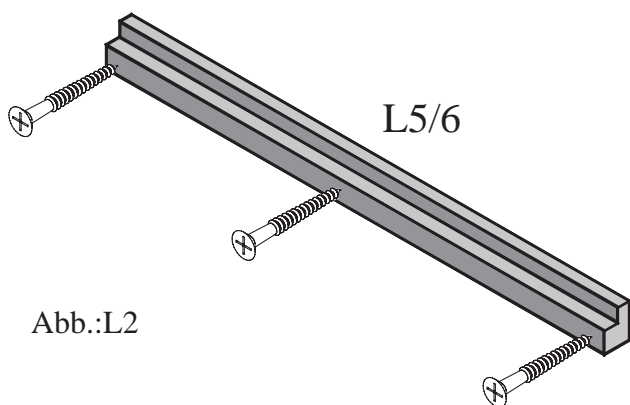

02

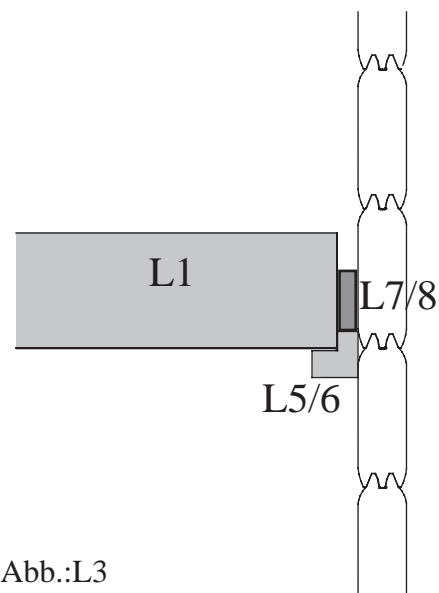
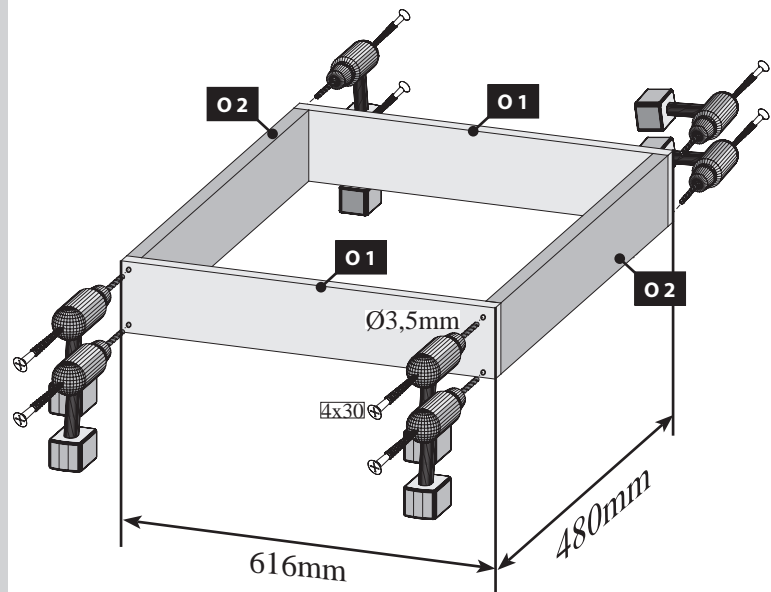
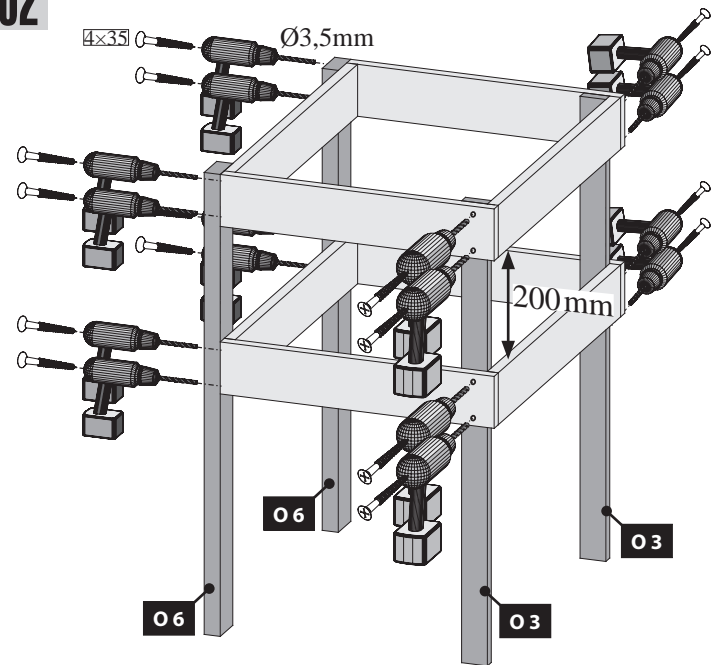

03









Abb. O 1/O 2

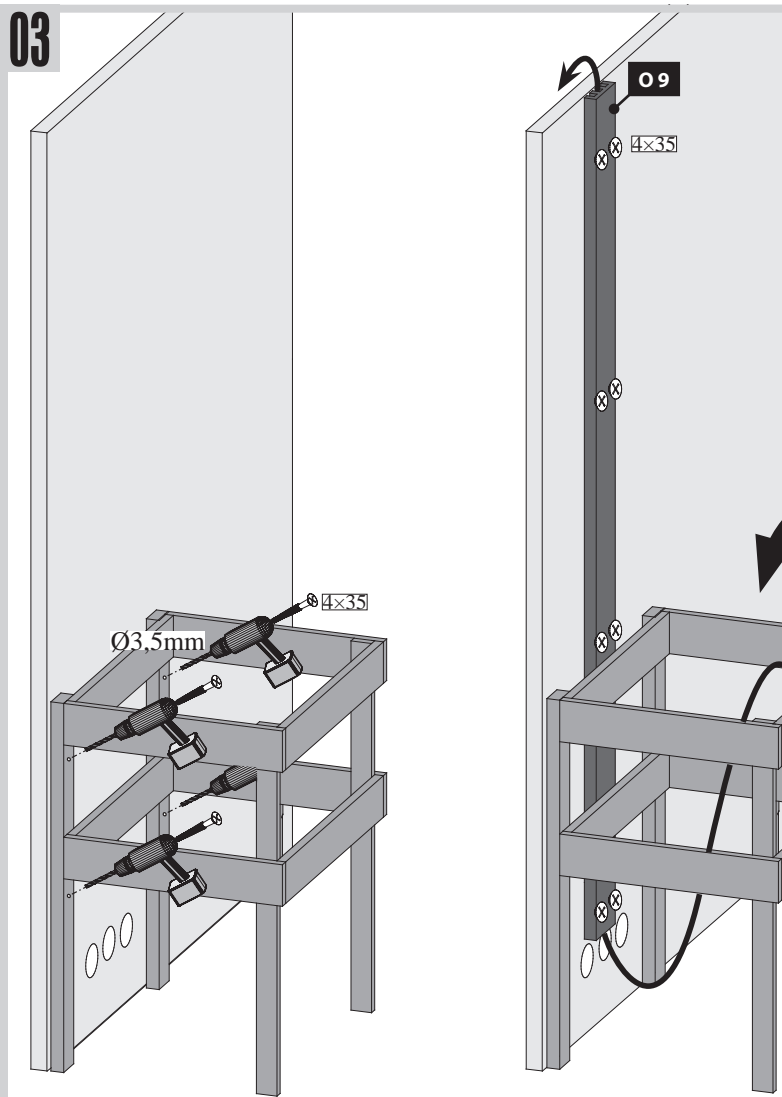

-  Einbau Glastür
-  Montage porte en verre
-  Installation of glass door
-  Montage van de glazen deur
-  Montaje de la puerta de cristal
-  Installazione portello di vetro

!!! 04 – 08 !!!



Abb.:O3



Abb.:O4

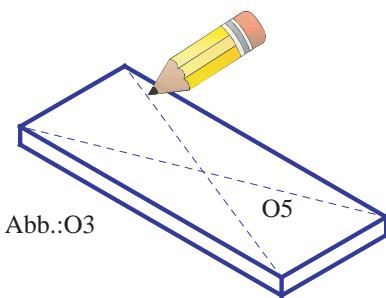

Abb.:O5

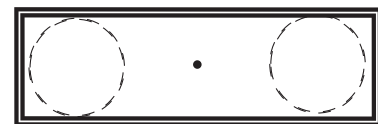

Abb.:O6

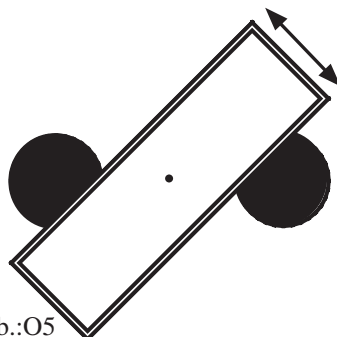

Abb.:O7

 Einbau Glastür

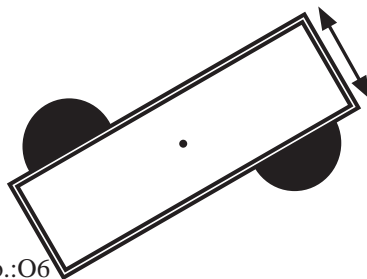
 Installation of glass door

 Montaje de la puerta de cristal

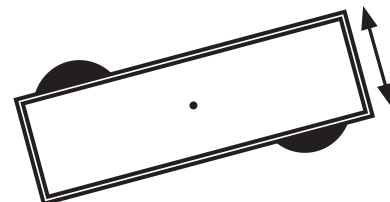
 Montage porte en verre

 Montage van de glazen deur

 Installazione portello di vetro

01

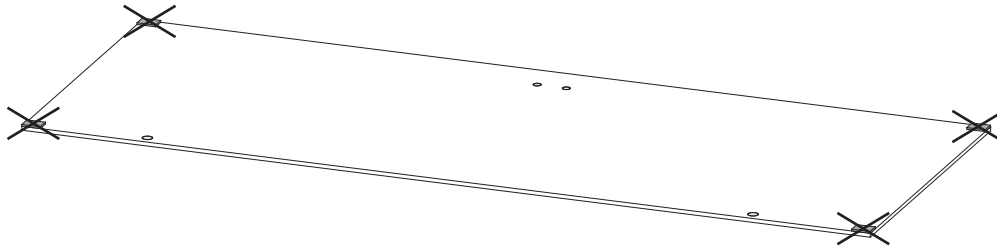

02

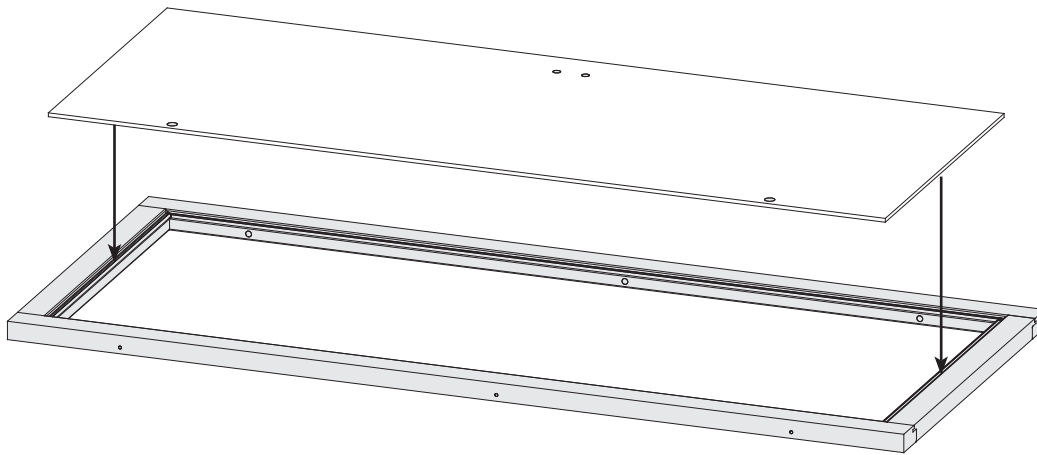

03

 Das Saunätürglas im Türrahmen ausrichten!

 Bien aligner le verre à vitre!

 To start building up the door you need to center the glass in the wooden frame!

 Plaats het glas van de sauna deur in het midden van het kozijn!

 ¡Centrar la puerta de cristal dentro del marco!

 Allineare il vetro dello sportello sauna al telaio della porta!

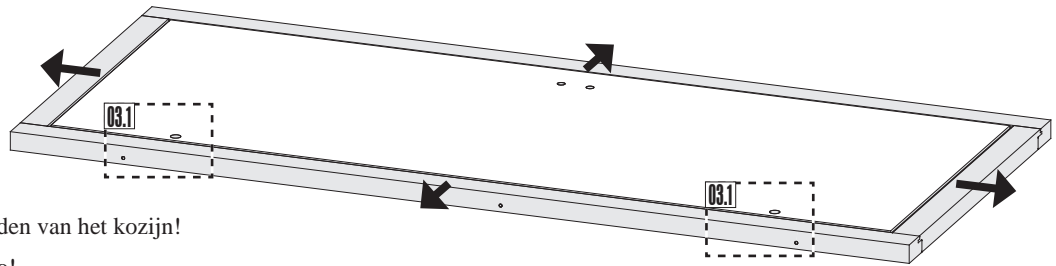

03.1-1

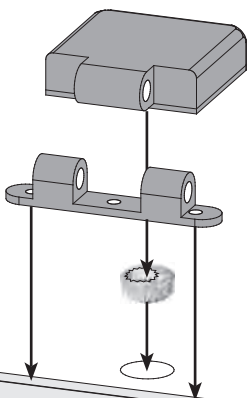

03.1-2

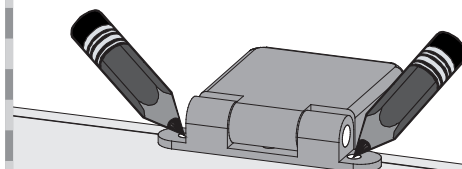

03.1-3

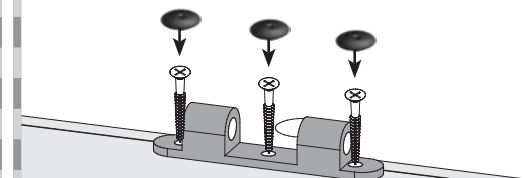

 Einbau Glastür

 Installation of glass door

 Montaje de la puerta de cristal

 Montage porte en verre

 Montage van de glazen deur

 Installazione portello di vetro

04

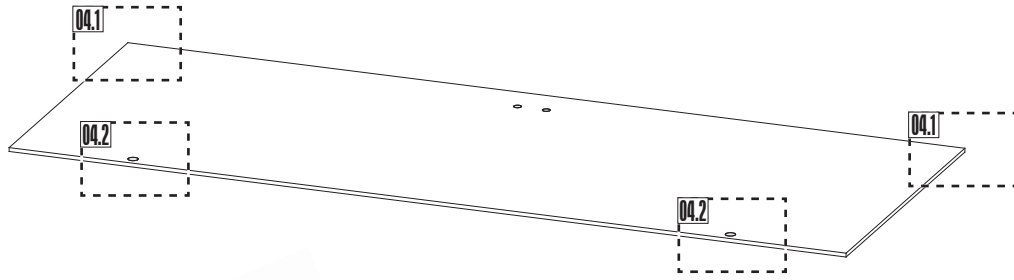

04.1-1

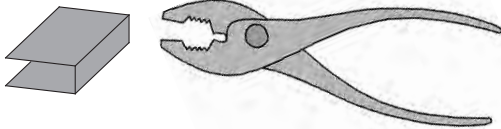

04.1-2

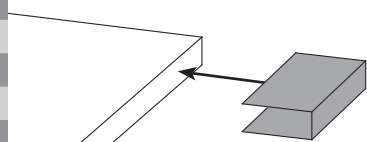

04.1-3

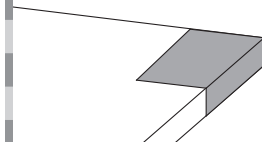

04.2-1

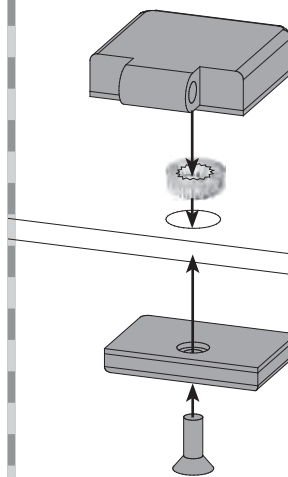

04.2-2

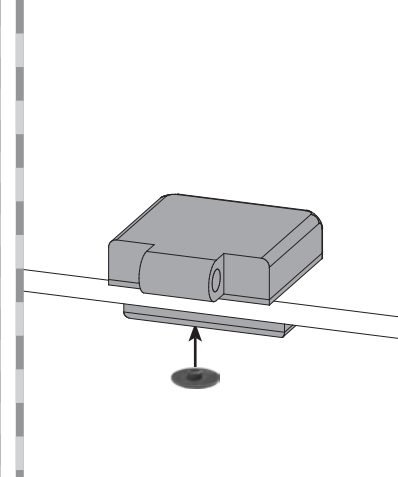

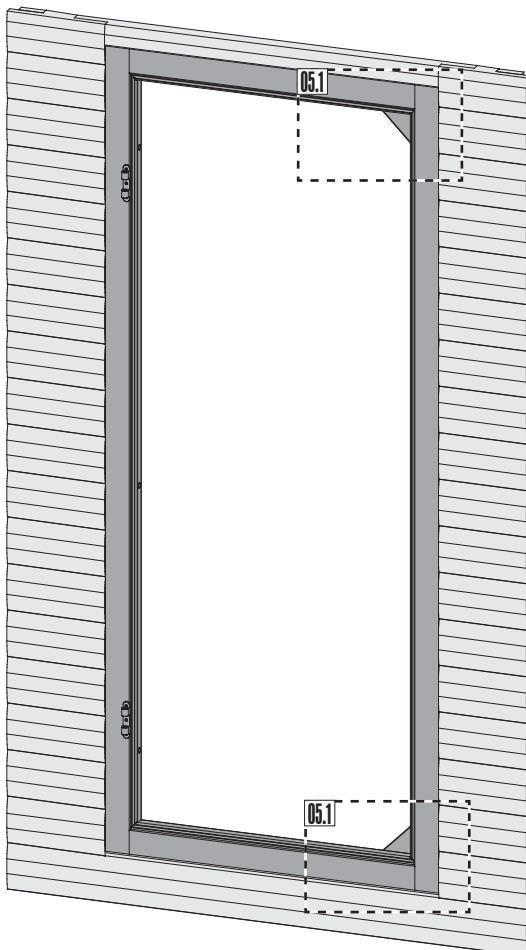

05





 Achtung: Alle Verstell-Excenter müssen in der Glasscheibe die gleiche Grundstellung haben!

 Attention: Tous les excentres de positionnement doivent avoir la même position de base dans la vitre!

 Attention: All adjustable eccentrics must have the same basic adjustment in the glass panel!

 Attentie: alle excentrische verstelelementen moeten in dezelfde stand in de glasplaat worden geplaatst!

 Atención: Todos los excéntricos regulables tienen que tener la misma posición base en la hoja de cristal.

 Attenzione: Tutti gli eccentrici di regolazione devono avere la stessa posizione base nella lastra di vetro!

05.1-1



05.1-2



 Einbau Glastür

 Installation of glass door

 Montaje de la puerta de cristal

 Montage porte en verre

 Montage van de glazen deur

 Installazione portello di vetro

06

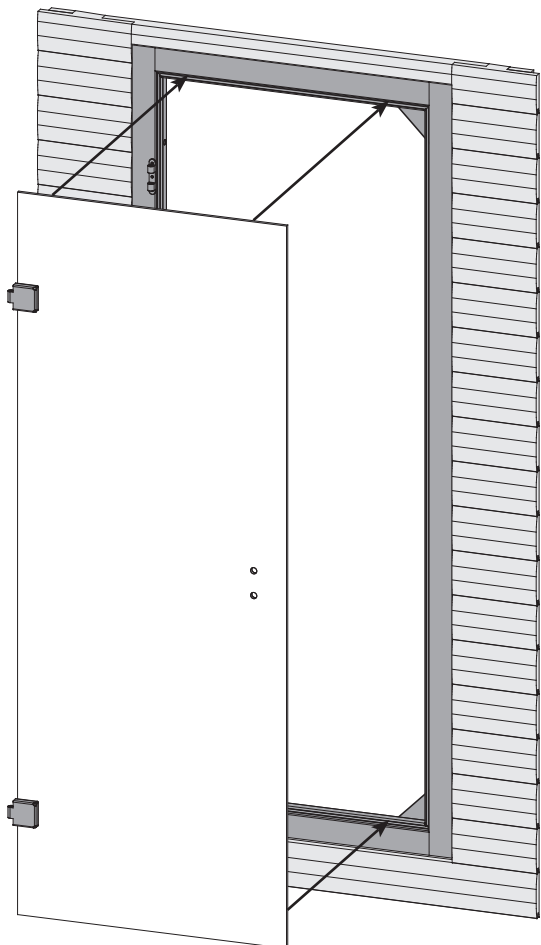

07

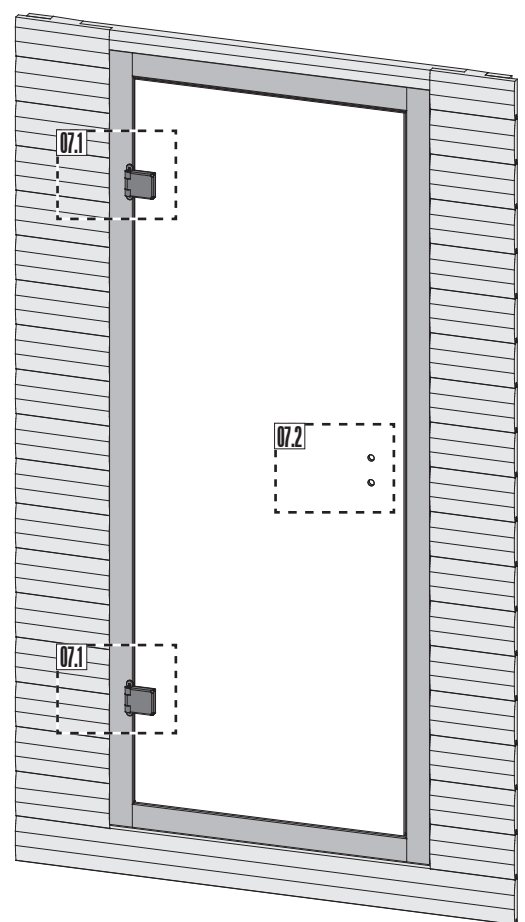

07.1

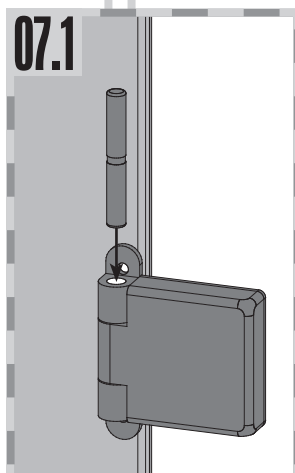

07.2-1

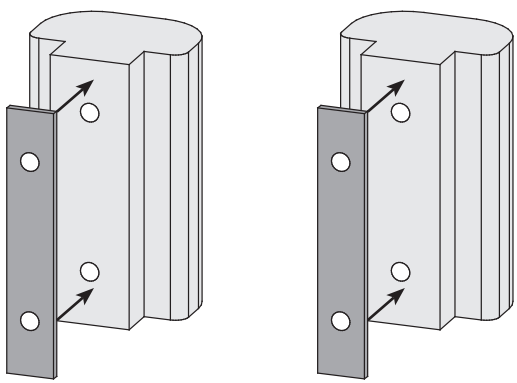

07.2-2

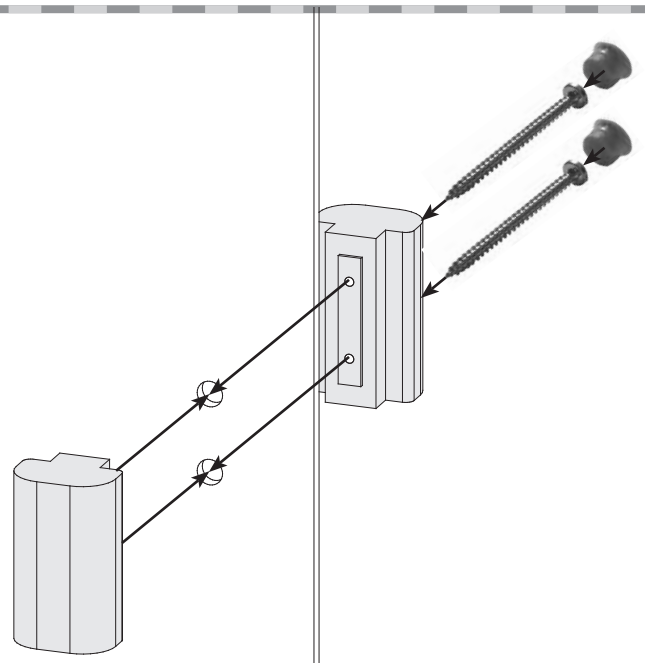

 Einbau Glastür

 Installation of glass door

 Montaje de la puerta de cristal

 Montage porte en verre

 Montage van de glazen deur

 Installazione portello di vetro

08

 **Seitenverstellung + Höhenverstellung**

Achtung: Alle Verstell-Excenter müssen in der Glasscheibe die gleiche Grundstellung haben!

 **Positionnement latéral + positionnement hauteur**

Attention: Tous les excentriques de positionnement doivent avoir la même position de base dans la vitre!

 **Lateral adjustment + height adjustment**

Attention: All adjustable eccentrics must have the same basic adjustment in the glass panel!

 **Zijverstelling + hoogteverstelling**

Attentie: alle excentrische verstelelementen moeten in dezelfde stand in de glasplaat worden geplaatst!

 **Regulación lateral + regulación de la altura**

Atención: Todos los excéntricos regulables tienen que tener la misma posición base en la hoja de cristal.

 **Regolazione laterale + regolazione dell'altezza**

Attenzione: Tutti gli eccentrici di regolazione devono avere la stessa posizione base nella lastra di vetro!

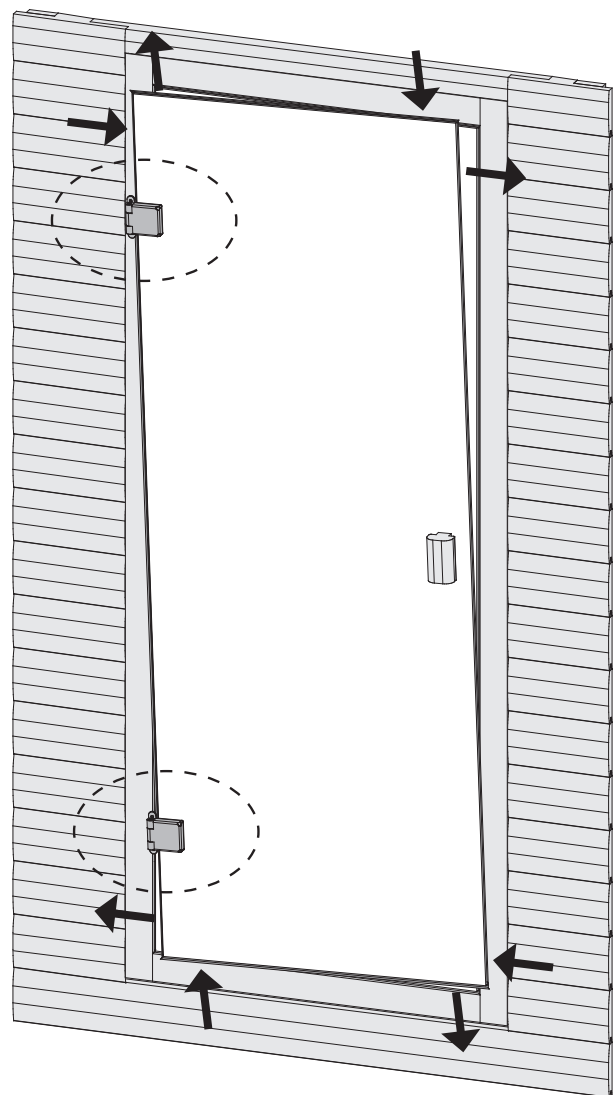
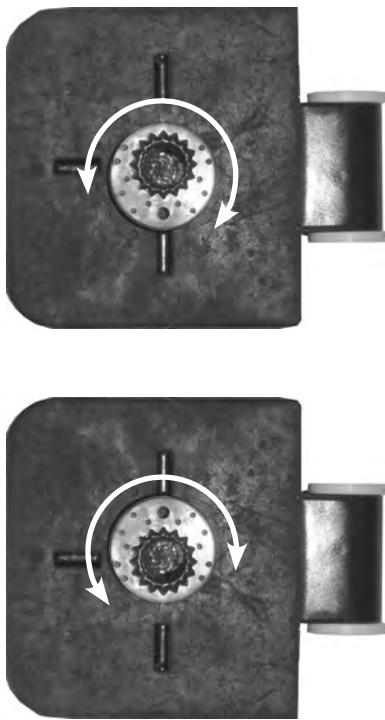



01

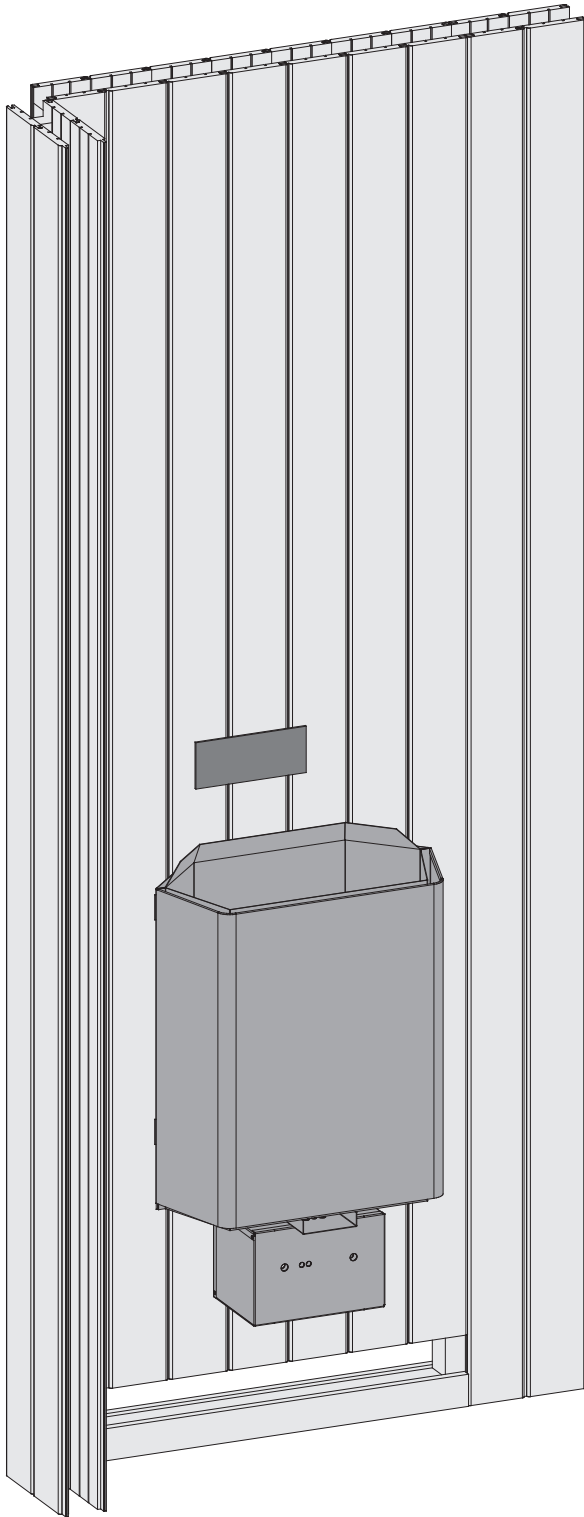

02

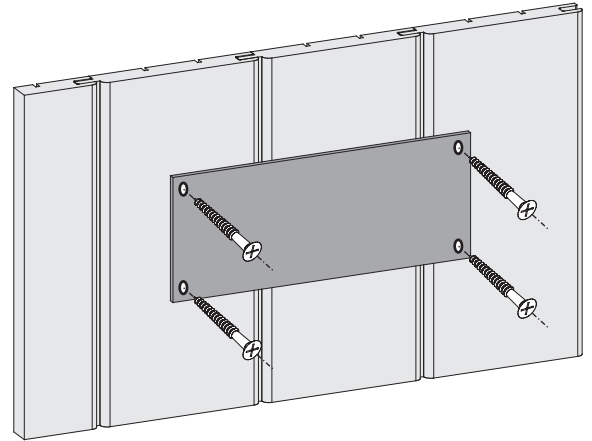

Entfernen Sie die Schutzfolie vom beiliegenden TÜV-Schild.

Lassen Sie den Saunaofen von einem zugelassenen Elektrofachmann anschließen. Dieser markiert den installierten Ofen auf dem TÜV-Schild.

Bringen Sie das TÜV-Schild an einer gut sichtbaren Stelle über dem Ofen an.

